



SPIRITUEUX | SPIRITS



SPIRITUEUX

SPIRITS



1897

CRÉATION DE LA VERRERIE
CREATION OF THE GLASS FACTORY

à Feuquières (FR)
in Feuquières (FR)

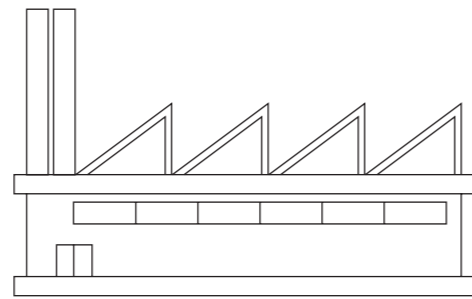

5

SITES DE PRODUCTION DE VERRE
GLASS FACTORIES

Feuquières, Le Havre, Arques (FR)
Ras Al Khaimah (EAU) (UAE) – Acatlán de Juárez (Jalisco, MX)



17

FILIALES AU NIVEAU MONDIAL
DISTRIBUTION SUBSIDIARIES
& OFFICES WORLDWIDE

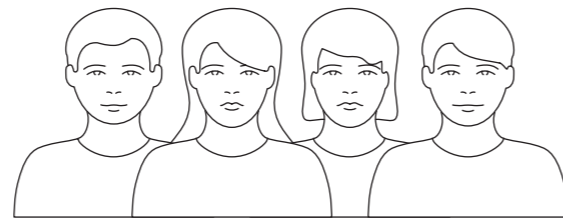

3400

COLLABORATEURS
PEOPLE

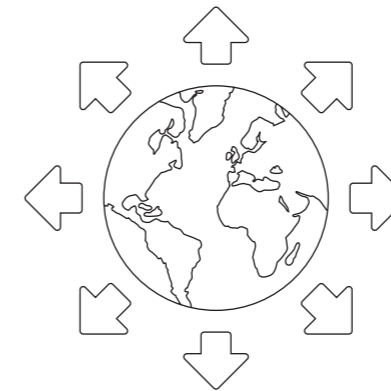

100

PAYS D'EXPORTATION
EXPORTING IN MORE THAN
100 COUNTRIES



4

SITES DE DÉCORATION
DECORATION FACTORIES

Feuquières, Arques, Coulommiers (FR)
Acatlán de Juárez (Jalisco, MX)

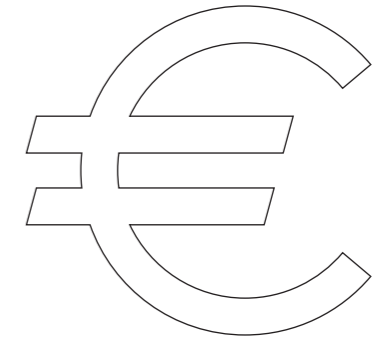

464 M€

CHIFFRE D'AFFAIRES EN 2018
TOTAL SALES IN 2018 (521 M\$)

dont 50 % réalisé à l'export
50 % of which is made through exports

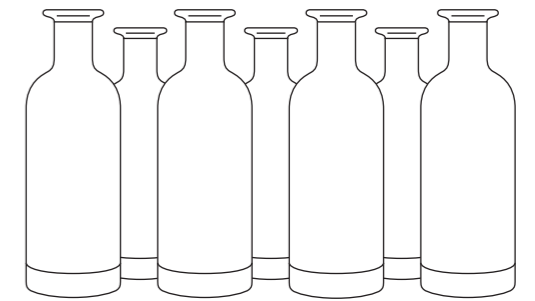

485 000

TONNES PRODUITES PAR AN
TONS PER YEAR

KEY FIGURES
CHIFFRES CLÉS



Spécialiste mondial de la fabrication, de la personnalisation et de la décoration des bouteilles haut de gamme en verre, Saverglass est reconnu pour son innovation, son expertise verrière, la qualité de ses produits et de leur design. Saverglass est le partenaire privilégié des designers, des créateurs de marques et des spiritueux premium et haut de gamme.

As a global specialist in manufacturing, customizing and decorating premium glass bottles, Saverglass is renowned for its innovation, glass-making expertise, product design and quality. Saverglass is the partner of choice for designers, brand creators, and premium and top-class spirits producers.

SAVERGLASS donne naissance, depuis plus de trente ans, à une offre de bouteilles de spiritueux unique, dont la particularité est portée par l'originalité et la qualité de ses designs, travaillés dans les moindres détails: piqûres ou semelles singulières, géométries des épaulements et des corps, maîtrise des épaisseurs et colonnes de verre, hauteurs et largeurs des flacons. L'utilisation minutieuse des codes du design se voit renforcée par la brillance, l'éclat et la transparence des objets conférée par la qualité du verre conçu dans nos usines et travaillé par nos verriers: le verre « Extra-Blanc de SAVERGLASS® ».

Dotée de plus de 110 gammes, la collection de modèles spiritueux offre une profondeur au travers de références oscillant entre 5 cl et 4,5 L, lui permettant aujourd'hui de s'imposer comme l'offre la plus complète du marché. Elle s'enrichit, par ailleurs, chaque année, de nouvelles formes et de nouveaux concepts issus de la recherche du pôle marketing de l'entreprise.

SAVERGLASS has been creating a unique range of spirits bottles for over 30 years. They owe their distinctive style to the originality and quality of their finely detailed designs: unusual punts and bases, unique shoulder and body shapes, skillfully produced columns, the masterful thickness of the glass, varying bottle heights and widths. The meticulous use of the design codes is enhanced by the brightness, radiance, and transparency of the bottles owing to the quality of the glass, which is designed in our factories and shaped by our glassmakers – the “Saverglass Extra White®”.

With more than 110 product ranges, the collection of spirits models is available in various sizes, with products ranging between 5 cl and 4.5 L, making it the most comprehensive offer on the market today. More product ranges are added every year, with new shapes and concepts that have been developed from research in the company's marketing division.

A UNIQUE, COMPLETE RANGE OF PRODUCTS!

UNE OFFRE GLOBALE UNIQUE!





SAVERGLASS accentue les possibilités de différenciation et de sophistication par la mise à disposition d'un éventail d'options de personnalisation, tels que: les teintes de verre (existantes ou à personnaliser), les gravures, mais aussi de nombreuses options de décoration: sérigraphies précieuses, organiques ou emails; coatings intégral, partiel ou dégradé, brillants ou mats, transparents ou opaques; satinage, sablage, ART & TOUCH ou la décoration en 3D; l'irisation; ... jusqu'à la pose d'accessoires (« pierre précieuse »; pièce métallique ou cuir...).

SAVERGLASS offre donc un champ extrêmement vaste de solutions au service de l'ultra-personnalisation haut de gamme, soit autant de réponses aux marques en quête de différenciation et de création de valeur!

SAVERGLASS also provides an array of customization options to highlight how products can be sophisticated and made to stand out even more. These options include glass tints (ready to order or customizable), engravings, and many decoration options, such as precious metal, organic or enamel silkscreen printing; full, partial or graded coating using gloss, matte, transparent or opaque finishes; frosted finish from acid-etching or sandblasting, ART & TOUCH or embossing; iridescent coating; and accessory fittings (gemstone, metal or leather items, for example).

SAVERGLASS offers an extremely broad range of products geared toward premium quality and ultra-customization, meaning that there is a whole host of solutions for those brands that seek to stand out from the crowd and create value.

DIFFERENTIATE YOURSELF

SE DIFFÉRENCIER D'AVANTAGE

1 SÉLECTION D'UN MODÈLE

SELECTION OF A MODEL

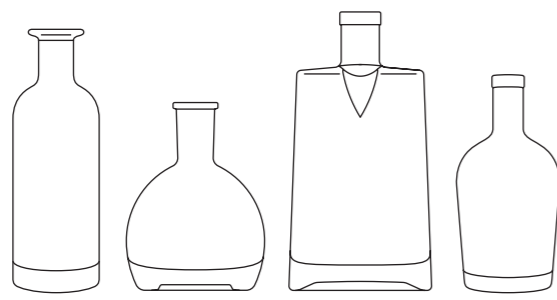

COLLECTION DE MODÈLES
ORIGINAUX DE SAVERGLASS
SAVERGLASS ORIGINAL
DESIGNS COLLECTION



MODÈLE SPÉCIFIQUE
SPECIFIC DESIGN

2 COULEURS DE VERRE

GLASS COLORS

EXTRA BLANC®
EXTRA WHITE®



TEINTES CLASSIQUES
CLASSIC COLORS



Antique
Antique Green



Jaune
Amber



Jaune Foncé
Dark Amber

SELECT COLORS®



Blue Ocean



Blue Ice



Blue Moon



Yellow Green



Grey Smoke

ONYX®



OUR OFFER
NOTRE OFFRE

3 GRAVURES

ENGRAVINGS

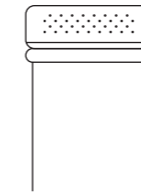

BAGUE
FINISH

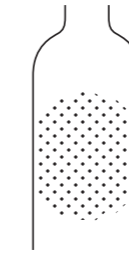

CORPS
BODY

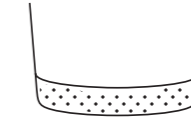

SEMELLE
BASE

4 DÉCORATION

DECORATION

SÉRIGRAPHIE
ORGANIQUE
ORGANIC SCREEN
PRINTING

SÉRIGRAPHIE ÉMAIL
ET MÉTAUX PRÉCIEUX
ENAMEL & PRECIOUS
METAL SCREEN PRINTING

MARQUAGE À CHAUD
HOT STAMPING

COATINGS

SAVERBOX®

SATINAGE
ACID-ETCHING

SABLAGE
SANDBLASTING

ART & TOUCH®

IRISATION
IRIDESCENT EFFECT

MÉTALLISATION
METALLIZATION

CHROMOS
DECALS

ACCESSOIRES
ACCESSORIES



SELECTION OF A MODEL
1 SÉLECTION D'UN MODÈLE



EXTRA BLANC® PAR SAVERGLASS
EXTRA WHITE FLINT® BY SAVERGLASS

GLASS COLORS
2 COULEURS DE VERRE



TEINTES CLASSIQUES
CLASSIC COLORS



SELECT COLORS®



ONYX® PAR SAVERGLASS
ONYX® BY SAVERGLASS



CORPS
BODY

3 ENGRAVINGS
GRAVURES



ÉPAULE
SHOULDER



BAGUE
FINISH





SÉRIGRAPHIE
ORGANIQUE
ORGANIC
SCREEN
PRINTING



COATING

SÉRIGRAPHIE
ÉMAIL
ET MÉTAUX PRÉCIEUX
ENAMEL AND
PRECIOUS METALS
SCREEN
PRINTING



SAVERBOX®



MARQUAGE
À CHAUD
HOT
STAMPING



SATINAGE
ACID
ETCHING



SABLAGE
SANDBLASTING



MÉTALLISATION
METALLIZATION

ART
& TOUCH®



CHROMOS
DECALS



IRISATION
IRIDESCENT
EFFECT



ACCESSOIRES
ACCESSORIES



DECANTERS ACHIEVEMENTS
RÉALISATIONS CARAFES



BOTTLES ACHIEVEMENTS
RÉALISATIONS BOUTEILLES



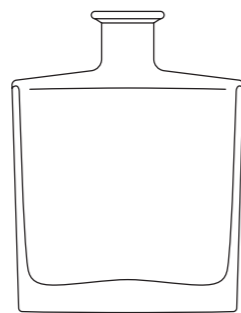

EXTRA PREMIUM

Il s'agit du segment le plus haut de gamme de la collection Saverglass ; On y trouve des modèles souvent complexes à produire en process automatique, de par leurs formes ou leurs caractéristiques, et qui sont dédiés à des spiritueux prestigieux. Le souci du détail y est omniprésent. Ces carafes et bouteilles de luxe se différencient par : les fortes épaisseurs de verre, signe de richesse et de qualité ; les sections qui font la différence ; la maîtrise de la répartition des colonnes de verre ; les épaulements plats et saillants ; les ailettes ; le choix des bagues proposés ; les arrêtes vives. This is the highest-end segment of the Saverglass collection. It includes models which are often too complex to manufacture through automated processes, due to their shapes and design features, and models which have been exclusively designed for premium spirits. Attention to detail pervades throughout. These decanters and luxury bottles are characterized by the following features: the thickness of the glass, a sign of luxury and quality; individual components that combine to create a distinct look; perfectly distributed columns; flat and prominent shoulders; flanges; a selection of collars; sharp edges.

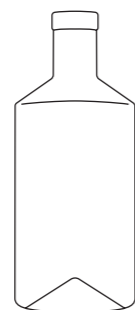

PREMIUM

C'est l'alliance du design et d'un positionnement prix attractif. Ce sont des modèles qui apportent de la différenciation tout en assurant une parfaite fonctionnalité au quotidien. On y trouve principalement des sections rondes, des piqûres aux formes innovantes et des poids de verre maîtrisés. The Premium range is where design and attractive price positioning blend in perfect harmony. These models are both unique and ensure perfect practicality on a daily basis. Rounded sections, innovatively shaped punts, and perfectly distributed weight are prominent features.

STANDINGS

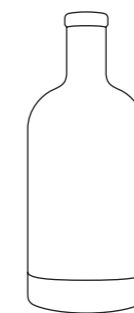

SUPER PREMIUM

Il s'agit du cœur de gamme de l'offre Saverglass. On retrouve ici : des formes de bouteilles au design travaillé ; des formes pouvant sortir des codes standards utilisés dans l'univers des spiritueux ; des semelles de verre épaisses ; des épaulements plats ; des sections carrées, des pans coupés. Tous ces détails distinctifs visent à apporter aux spiritueux un positionnement haut de gamme. The Super Premium collection is Saverglass' core range. Here our customers will find: bottles shaped to a tried and tested design; silhouettes that evoke the classic range of designs used in the spirits industry; thick glass bases; flat shoulders; sections freed from the constraints of curved designs; these distinctive details come together to make the spirits a high-end product.



STANDARD PREMIUM

Il s'agit de l'entrée de gamme chez Saverglass. Ce sont des formes standards, classiques, aux dimensionnels standards sur le marché des spiritueux mais fabriqués selon le cahier des charges qualité Saverglass : contrôles permanents tout au long du process pour garantir les productions, attention particulière apportée à la brillance du verre et à l'aspect de la peau de verre. The Standard Premium range is Saverglass' entry-level collection. Here our customers will find classic industry-standard shapes and dimensions elevated to Saverglass' quality specifications: continual checks to guarantee the quality of the manufacturing process, and meticulous attention to intensifying the brilliance and sheen of the glass.

EXTRA PREMIUM	PAGE	PROF. GAMME	37,5 CL	50 CL	70 CL	75 CL	100 CL	150 CL
ALIX	40	3			●	●	●	
ATTITUDE	42	3			●	●	●	
DROP	44	3			●	●	●	●
EDEN	46	3	●		●	●		
GREG	48	2			●	●		
HELIOS	50	3		●	●	●		
HERCULES	52	2			●	●		
JENS	54	4		●	●	●		●
JIM	56	2			●	●		
JULES	58	2			●	●		
KHEOPS	60	2			●	●		
MADRAS	62	1			●	●		
OLYMPE	64	2			●	●		
SCOTT	66	2			●	●		
YOGI	68	3		●	●	●		

SUPER PREMIUM	PAGE	PROF. GAMME	37,5 CL	50 CL	70 CL	75 CL	100 CL	150 CL
ARÔME	70	2			●	●		
ATHENA	72	2			●	●		
DANAÏ	74	1			●	●		
DIVA	76	2			●	●		
ELLIPTIC	78	2			●	●		
PRINCE	80	2			●	●		
ZENITH	82	2			●	●		

DECANTERS — RANGE DEPTH OVERVIEW

CARAFES — RÉCAPITULATIF PROFONDEUR DE GAMMES

EXTRA PREMIUM			PAGE	PROF. GAMME	5 CL	5 CL	10 CL	20 CL	25 CL	35 CL	37,5 CL	50 CL	70 CL	75 CL	100 CL	150 CL	175 CL	300 CL	450 CL	
ATTITUDE HAUTE	90	2											●	●						
AXEL	93	8			●					●	●	●	●	●	●			●		
LEXA	96	2											●	●						
QBIC	99	6								●	●	●	●	●	●					

SUPER PREMIUM			PAGE	PROF. GAMME	5 CL	5 CL	10 CL	20 CL	25 CL	35 CL	37,5 CL	50 CL	70 CL	75 CL	100 CL	150 CL	175 CL	300 CL	450 CL	
ARIANE 1	103	13			●	●	●			●	●	●	●	●	●	●	●	●	●	●
BAHIA	182	4			●					●	●	●								
BELLISSIMA	106	6					●			●	●	●				●				
BUBBLE	108	2											●	●						
BYBLOS SPIRIT	180	1											●	●						
CAPTAIN HOOK	110	2											●	●						
CEREMONY BASSE	112	2											●	●						
CEREMONY HAUTE	112	1											●	●						
DIAMOND	114	2											●	●						
DYNAMITE	116	2											●	●						
EMPIRE BASSE	118	2											●	●						
EMPIRE HAUTE	118	2											●	●						
ESSENCIA	120	2											●	●						
EXCEPTION	122	4											●	●	●					
FIDJI	125	9			●					●	●	●	●	●	●			●	●	
FLAVOUR	128	2											●	●						
GEISHA	130	4											●	●	●					
H DOZO	132	2											●	●						
ISLAY	134	2											●	●						
KENDO SPIRIT	137	10			●					●	●	●	●	●	●	●	●	●	●	●
KENDO SQUARE	140	2											●	●						
KIMONO	142	5			●								●	●	●			●		
LITTLE PASHA	144	4											●	●	●					●
LITTLE SUMO	147	6								●	●	●	●	●	●					
LONG ISLAND	151	6			●					●	●	●	●	●	●					
MIYU	154	2											●	●						
NEOS	157	8			●			●		●	●	●	●	●	●					
NESS	160	2											●	●						
NUMBER ONE	162	2											●	●						
OSLO	165	11			●			●		●	●	●	●	●	●	●	●	●	●	●
OSLO APOTHEK	169	4					●						●	●						
PEARL	172	2											●	●						
PIRATE	174	2											●	●						
PREMIÈRE SPIRIT	180	1											●	●						
SABA	182	1										●								
SINGLE	176	5								●	●	●	●	●				●		
TONIC	178	2											●	●						

PREMIUM			PAGE	PROF. GAMME	5 CL	5 CL	10 CL	20 CL	25 CL	35 CL	37,5 CL	50 CL	70 CL	75 CL	100 CL	150 CL	175 CL	300 CL	450 CL	
ARIANE 2	185	8					●	●		●		●	●	●	●					
BOSTON	188	6					●					●	●	●	●			●		
BOTANIC	190	2											●	●						
DISTIL'ER	192	3											●	●						
FORTY-SIX	194	2											●	●						
INOLENCE SPIRIT	196	2											●	●						
MARC GRAND CRU	210	1											●	●						
LA MILLÉSIME	198	2											●	●						
MIXOLOGIST	200	4											●	●						
NORMANDIE	202	4											●	●				●		
OXYGEN	205	7											●	●	●	●	●	●	●	●
TIME SQUARE BASSE	208	2											●	●						
TIME SQUARE HAUTE	208	3											●	●						
FLÛTE ALTUS SPIRIT	212	6											●	●	●	●	●	●	●	●
INA	214	2											●	●						
TAM-TAM	216	2											●	●						
THAÏ	218	6											●	●	●	●	●	●	●	●
TSAR	220	3											●	●	●					
VIRGIN	223	4											●	●	●	●	●	●	●	●
ZADIG	227	7											●	●	●	●	●	●	●	●

STANDARD PREMIUM			PAGE	PROF. GAMME	5 CL	5 CL	10 CL	20 CL	25 CL	35 CL	37,5 CL	50 CL	70 CL	75 CL	100 CL	150 CL	175 CL	300 CL	450 CL	
ANGLAISE	253	1																		
BAMBOO	232	5																		
BASQUAISE	235	7																		
CALVADOS	239	4																		
CHARENTAISE	243	3																		
COGNAC	253	2																		
COGNAÇAISE	243	7																		
FLÛTE DISTILLATEUR	249	7																		
MARIE-LAURENCE	253	1																		
MARTINIQUE	246	2																		
NATHALIE	253	2																		
NORMANDE HAUTE	239	1																		
PAILLARDE	243	2																		
WHISKY STANDARD	253	1																		
WINCH	230	2																		

BOTTLES — RANGE DEPTH OVERVIEW

BOUTEILLES — RÉCAPITULATIF PROFONDEUR DE GAMMES

CARAFES AFRES

DECANTERS

ALIX	40
ARÔME	70
ATHENA	72
ATTITUDE	42
DANAÏ	74
DIVA	76
DROP	44
EDEN	46
ELLIPTIC	78
GREG	48
HELIOS	50
HERCULES	52
JENS	54
JIM	56
JULES	58
KHEOPS	60
MADRAS	62
OLYMPE	64
PRINCE	80
SCOTT	66
YOGI	68
ZENITH	82

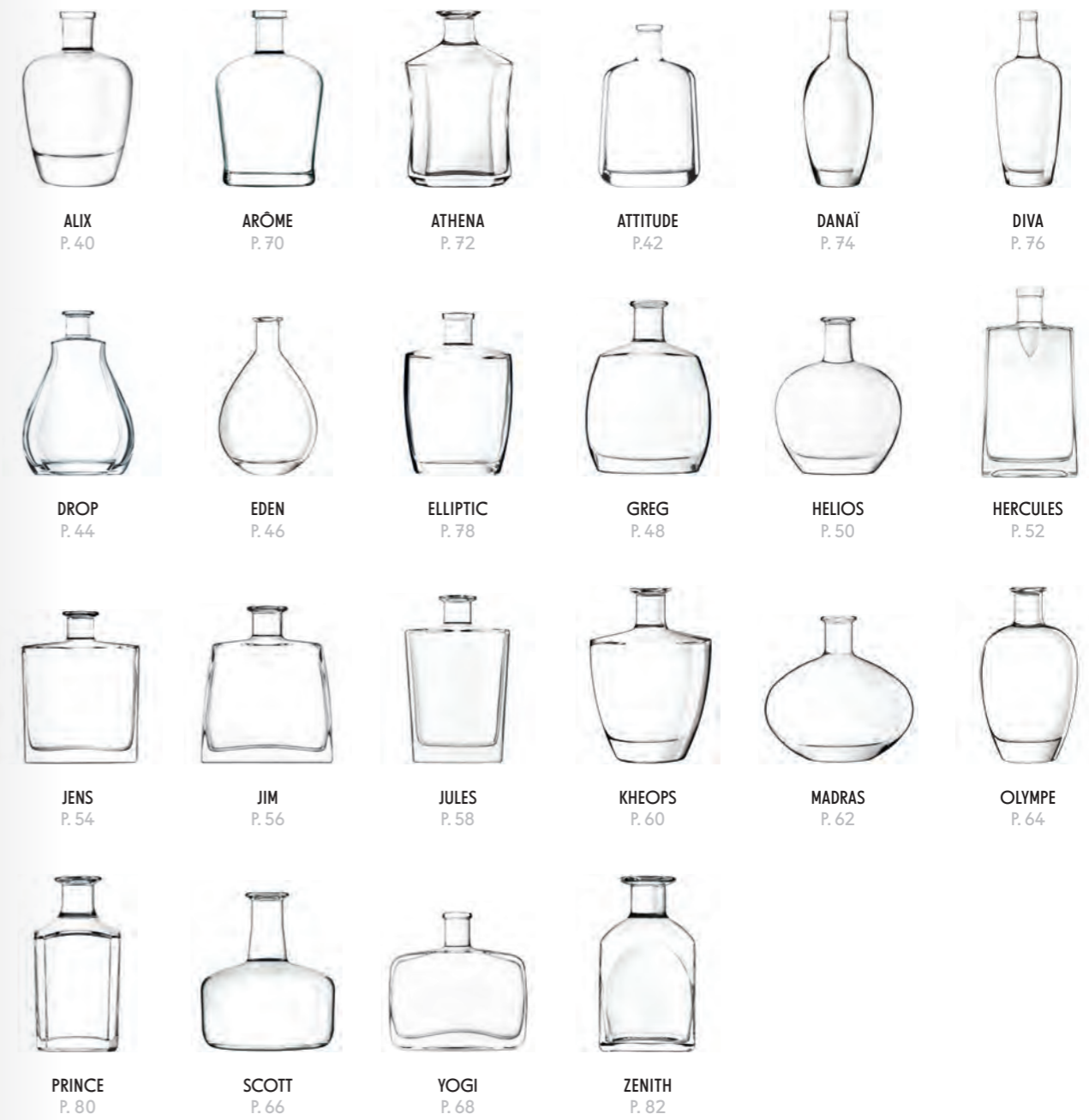

ALPHABETICAL TABLE OF CONTENTS
SOMMAIRE ALPHABÉTIQUE

VISUAL TABLE OF CONTENTS
SOMMAIRE VISUEL

ALIX

EXTRA PREMIUM



40 | 41



Évoquant la douceur et le galbe d'une pomme ronde et pulpeuse, la voluptueuse ALIX charme tous les épicuriens. Sa silhouette, d'abord, marquée par la rondeur de sa section et la modernité de sa bague plate conique, pique la curiosité du regard. Son poids exceptionnel et son impressionnante semelle de verre portent l'estocade finale. Grande séductrice, ALIX soulignera de ses charmes les élixirs les plus rares, en recherche d'exception.

Evoking the sweetness and sumptuous curves of a round juicy apple, the voluptuous ALIX charms all lovers of fine dining and drinking. For starters, its striking silhouette with the fullness of its round cross-section and contemporary flat tapered finish is a real eye-catcher. Its exceptional weight and impressive glass base are the cherry on the cake. Intensely alluring, ALIX will accentuate the charms of the rarest liqueurs, on a quest for the extraordinary.



Contenance Capacity	70 cl 23.67 oz	75 cl 25.36 oz	100 cl 33.82 oz
Référence Reference	4321	4322	5069
Bague Finish	 Plate Conique	 Plate Conique	 Plate Conique
Poids Weight	1200 g 42.33 oz	1200 g 42.33 oz	1486 g 52.42 oz
Hauteur totale [A] Overall height	185 mm 7.28 in	185 mm 7.28 in	203,5 mm 8.01 in
Section maxi [B] Maxi section	118,5 mm 4.67 in	121,3 mm 4.78 in	131,6 mm 5.18 in
Diamètre de débouchage [D] Entrance bore diameter	23 mm 0.91 in	23 mm 0.91 in	23 mm 0.91 in
Teinte Glass color	○ Extra Blanc Extra White Flint	○ Extra Blanc Extra White Flint	○ Extra Blanc Extra White Flint

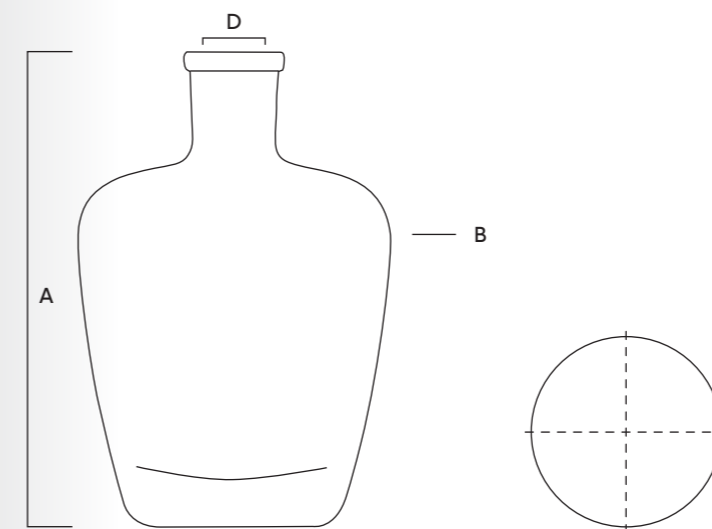

Modèle déposé « Design Saverglass »
Registered "Design Saverglass"

ATTITUDE

EXTRA PREMIUM





42 | 43



S'adonnant à l'art raffiné du trompe-l'œil, la carafe ATTITUDE explore avec modernité le dialogue contenant-contenu. Les ailettes ourlent le flacon pour mieux le dessiner et créer ainsi un effet de pincement, qui magnifie l'alcool comme s'il était en suspension. Doté d'une section ovale et d'une bague plate conique très fine, le design racé de la carafe ATTITUDE magnifiera les élixirs les plus exclusifs.

Indulging in the fine art of optical illusion, the ATTITUDE decanter explores the interplay between container and content with a contemporary twist. The flanges hem the sides of bottle to give it a more refined outline, giving the impression of being pinched in, which accentuates the alcohol to look as if it were in suspension. With an oval cross-section and a very fine flat tapered finish, the ATTITUDE decanter's elegant design will augment the most exclusive liqueurs.



Contenance Capacity	70 cl 23.67 oz	70 cl 23.67 oz	75 cl 25.36 oz	75 cl 25.36 oz	100 cl 33.82 oz
Référence Reference	5034	5034	5035	5035	5849
Bague Finish	 Plate Conique	 GPI 400/33	 Plate Conique	 GPI 400/33	 Plate Conique
Poids Weight	1210 g 42.68 oz	1210 g 42.68 oz	1220 g 43.03 oz	1220 g 43.03 oz	1550 g 54.67 oz
Hauteur totale [A] Overall height	230,3 mm 9.07 in	237,6 mm 9.35 in	230,3 mm 9.07 in	237,6 mm 9.35 in	255,8 mm 10.07 in
Section maxi [B] Maxi section	146,6 mm 5.77 in	146,6 mm 5.77 in	146,6 mm 5.77 in	146,6 mm 5.77 in	163,5 mm 6.44 in
Épaisseur maxi [C] Maxi thickness	71,5 mm 2.81 in	71,5 mm 2.81 in	75,4 mm 2.97 in	75,4 mm 2.97 in	79,7 mm 3.14 in
Diamètre de débouchage [D] Entrance bore diameter	23 mm 0.91 in	21,5 mm 0.85 in	23 mm 0.91 in	21,5 mm 0.85 in	23 mm 0.91 in
Teinte Glass color	○ Extra Blanc Extra White Flint	○ Extra Blanc Extra White Flint	○ Extra Blanc Extra White Flint	○ Extra Blanc Extra White Flint	○ Extra Blanc Extra White Flint

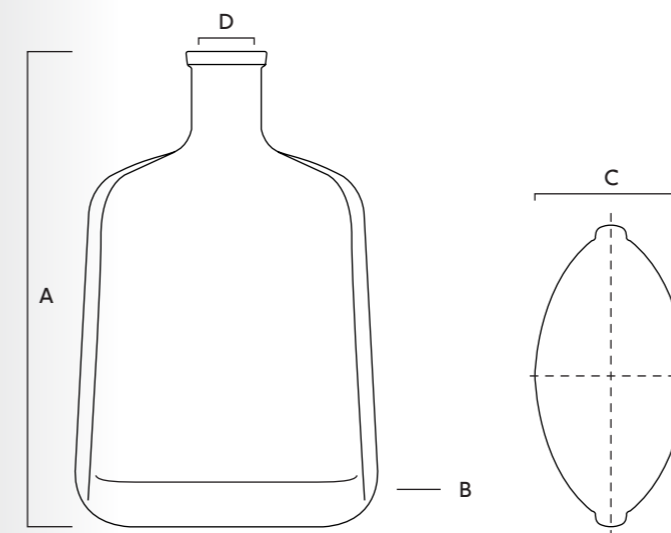

Modèle déposé « Design Saverglass »
Registered "Design Saverglass"

DROP

EXTRA PREMIUM



Opulente et sensuelle, DROP dépose avec douceur ses lignes courbes sur une belle semelle de verre. Dotée d'un large facing adapté à la personnalisation et d'une bague carnette distinctive, elle impose avec style son caractère unique.

Opulent and sensual, DROP features a curvy outline delicately placed atop a magnificent glass base. The bottle showcases its unique character elegantly with its distinctive carnette finish and a wide label panel designed for customization.



Contenance Capacity	70 cl 23.67 oz	75 cl 25.36 oz	150 cl 50.73oz
Référence Reference	4807	4808	4989
Bague Finish	 Carnette	 Carnette	 Carnette
Poids Weight	1015 g 35.8 oz	1025 g 36.16 oz	1905 g 67.2 oz
Hauteur totale [A] Overall height	223,2 mm 8.79 in	223,2 mm 8.79 in	280,5 mm 11.04 in
Section maxi [B] Maxi section	150,8 mm 5.94 in	150,8 mm 5.94 in	190,6 mm 7.5 in
Épaisseur maxi [C] Maxi thickness	60,9 mm 2.4 in	63,9 mm 2.52 in	77,3 mm 3.04 in
Diamètre de débouchage [D] Entrance bore diameter	23 mm 0.91 in	23 mm 0.91 in	28 mm 1.1 in
Teinte Glass color	○ Extra Blanc Extra White Flint	○ Extra Blanc Extra White Flint	○ Extra Blanc Extra White Flint

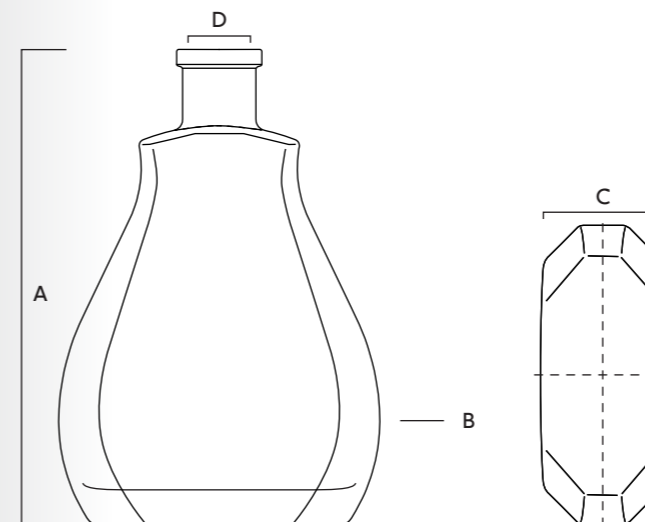

Modèle déposé « Design Saverglass »
Registered "Design Saverglass"

EDEN

EXTRA PREMIUM



46 | 47



EDEN joue la partition de l'épure. Son design mêle rondeur et douceur, empruntant ses contours à ceux des galets délicatement façonnés par la mer. A la fois sobre et intemporelle, EDEN s'adapte à toutes les exigences. EDEN existe également en format 37,5 cl.

EDEN sings the song of simplicity. Its design mixes roundness and softness, borrowing its curvaceous form from pebbles delicately shaped by the sea. Both simple and timeless, EDEN adapts to every need. EDEN is also available in a 37.5 cl capacity.



Contenance Capacity	37,5 cl 12.68 oz	70 cl 23.67 oz	75 cl 25.36 oz
Référence Reference	3659	2239	2291
Bague Finish	 Carnette	 Carnette	 Carnette
Poids Weight	500 g 17.64 oz	900 g 31.75 oz	900 g 31.75 oz
Hauteur totale [A] Overall height	189,6 mm 7.46 in	235,8 mm 9.28 in	235,8 mm 9.28 in
Section maxi [B] Maxi section	121,4 mm 4.78 in	151,1 mm 5.95 in	151,1 mm 5.95 in
Épaisseur maxi [C] Maxi thickness	59,4 mm 2.34 in	70,7 mm 2.78 in	72,6 mm 2.86 in
Diamètre de débouchage [D] Entrance bore diameter	18,5 mm 0.73 in	23 mm 0.91 in	23 mm 0.91 in
Teinte Glass color	○ Extra Blanc Extra White Flint	○ Extra Blanc Extra White Flint	○ Extra Blanc Extra White Flint

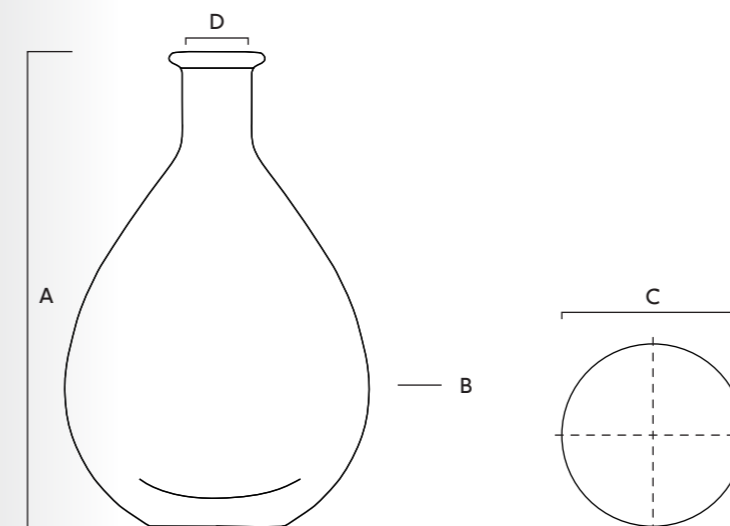



Modèle déposé « Design Saverglass »
Registered "Design Saverglass"



Le flacon GREG, affiche un design pur qui mise audacieusement sur la rigueur des lignes géométriques et un facing viril. L'ensemble s'harmonise à un contour tout en douceur et une section ovale qui contribuent à l'originalité de la proposition.

The GREG bottle boasts a clean design that boldly builds on sturdy geometric lines and a strong label panel. This combination is paired with a soft silhouette and oval cross-section, making the bottle distinct.



Contenance Capacity	70 cl 23.67 oz	75 cl 25.36 oz
Référence Reference	3209	3443
Bague Finish	 Carnette	 Carnette
Poids Weight	900 g 31.75 oz	900 g 31.75 oz
Hauteur totale [A] Overall height	201,8 mm 7.94 in	201,8 mm 7.94 in
Section maxi [B] Maxi section	146 mm 5.75 in	146 mm 5.75 in
Épaisseur maxi [C] Maxi thickness	70 mm 2.76 in	72,2 mm 2.84 in
Diamètre de débouchage [D] Entrance bore diameter	23 mm 0.91 in	23 mm 0.91 in
Teinte Glass color	○ Extra Blanc Extra White Flint	○ Extra Blanc Extra White Flint

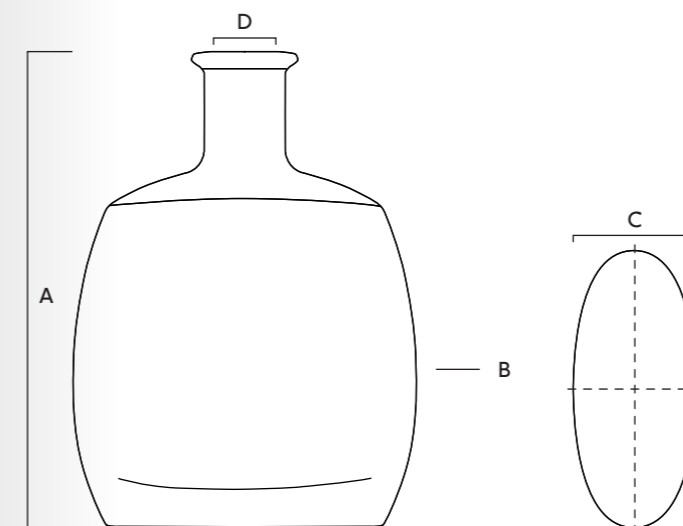

Modèle déposé « Design Saverglass »
Registered "Design Saverglass"



Cette carafe au tempérament solaire transmet une belle énergie. Sa silhouette, sphérique caractérisée par une section ovale, présente des contours généreux et doux. Sa nature flamboyante se manifeste par son large facing adapté à la personnalisation et la transparence du verre qui réfléchit la lumière. HELIOS se décline également en 50 cl.

With luminous character, this decanter radiates positive energy. Its spherical silhouette, characterized by an oval cross-section, has generous and soft outlines. The bottle's flamboyant nature can be seen in its wide customizable label panel and a glass transparency that allows light to bounce off of it. HELIOS is also available in a 50 cl capacity.



Contenance Capacity	50 cl 16.91 oz	70 cl 23.67 oz	75 cl 25.36 oz
Référence Reference	2785	2304	2451
Bague Finish	 Carnette	 Carnette	 Carnette
Poids Weight	680 g 23.99 oz	900 g 31.75 oz	900 g 31.75 oz
Hauteur totale [A] Overall height	188 mm 7.4 in	209,5 mm 8.25 in	209,5 mm 8.25 in
Section maxi [B] Maxi section	152 mm 5.98 in	170 mm 6.69 in	170 mm 6.69 in
Épaisseur maxi [C] Maxi thickness	62,2 mm 2.45 in	68,9 mm 2.71 in	71,1 mm 2.8 in
Diamètre de débouchage [D] Entrance bore diameter	23 mm 0.91 in	23 mm 0.91 in	23 mm 0.91 in
Teinte Glass color	○ Extra Blanc Extra White Flint	○ Extra Blanc Extra White Flint	○ Extra Blanc Extra White Flint

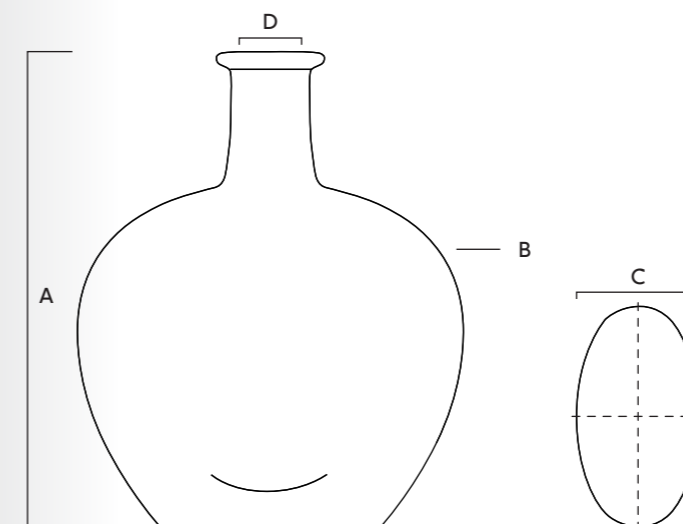

Modèle déposé « Design Saverglass »
Registered "Design Saverglass"

HERCULES

EXTRA PREMIUM

52 | 53



La carafe HERCULES ne s'offre qu'à des produits d'exception. Éléance naturelle, angles saillants et colonnes de verre tendues, doté d'un facing spacieux et d'un bombage subtil reflétant le liquide dans la semelle s'additionnent harmonieusement pour valoriser les plus beaux atours des marques. Ce flacon ne passera jamais inaperçu. Remarquable et héroïque, par nature!

The HERCULES decanter is reserved for exceptional products. A harmonious combination of natural elegance, strong angles, taut glass columns, a spacious label panel, and a subtle flare toward the bottom, which reflects the liquid in the base, all come together to bring a brand's finest features to the fore. This bottle will always turn heads. Remarkable and heroic by nature!



Contenance
Capacity

70 cl
23.67 oz

75 cl
25.36 oz

Référence
Reference

5813

5922

Bague
Finish



Poids
Weight

1165 g
41.09 oz

1200 g
42.33 oz

Hauteur
totale [A]
Overall
height

251 mm
9.88 in

251 mm
9.88 in

Section
maxi [B]
Maxi
section

128,8 mm
5.07 in

132,9 mm
5.23 in

Épaisseur
maxi [C]
Maxi
thickness

63,5 mm
2.5 in

65,4 mm
2.57 in

Diamètre de
débouchage
[D] Entrance
bore diameter

23 mm
0.91 in

23 mm
0.91 in

Teinte
Glass color

○ Extra Blanc
Extra White Flint

○ Extra Blanc
Extra White Flint

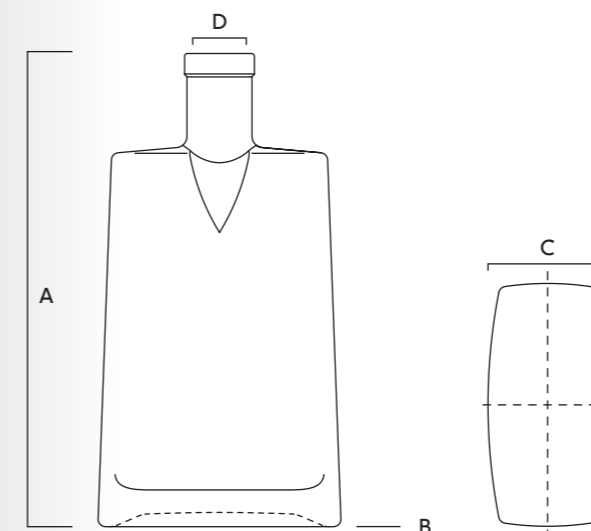

Modèle déposé « Design Saverglass »
Registered "Design Saverglass"

JENS

EXTRA PREMIUM

54 | 55



C'est à un trait vif et assuré que l'on doit le caractère moderne et intemporel de la carafe JENS. De section rectangulaire habilement adoucie par des faces principales galbées, le flacon présente un large facing carré. Ses épaules presque horizontales, son col raccourci et ses belles épaisseurs de verre peaufinent un style masculin maîtrisé qui donne le ton juste à cette carafe. Disponible à partir de 50 cl et jusqu'au format exceptionnel de 150 cl, JENS signe un brillant exercice d'élégance contemporaine unique et luxueuse.

The contemporary and timeless character of the JENS decanter is down to its bright and confident nature. The bottle features a rectangular cross-section skillfully softened by rounded panels and a large square label panel. Its slightly inclined shoulders, shortened neck and fine glass thickness are the finishing touches on a masculine design that sets the right tone for this decanter. Available from 50 cl up to an extra-large bottle capacity of 150 cl, JENS is a stunning example of unique and luxurious contemporary elegance.

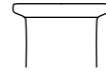
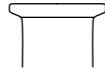
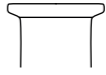
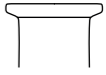

Contenance Capacity	50 cl 16.91 oz	70 cl 23.67 oz	75 cl 25.36 oz	150 cl 50.73 oz
Référence Reference	4788	3653	3665	4990
Bague Finish	 Carnette	 Carnette	 Carnette	 Carnette
Poids Weight	785 g 27.69 oz	1136 g 40.07 oz	1070 g 37.74 oz	1960 g 69.14 oz
Hauteur totale [A] Overall height	172,2 mm 6.78 in	193,7 mm 7.63 in	193,7 mm 7.63 in	229,6 mm 9.04 in
Section maxi [B] Maxi section	135,3 mm 5.33 in	152 mm 5.98 in	152 mm 5.98 in	180,3 mm 7.1 in
Épaisseur maxi [C] Maxi thickness	53,4 mm 2.1 in	59,2 mm 2.33 in	60,6 mm 2.39 in	83,6 mm 3.29 in
Diamètre de débouchage [D] Entrance bore diameter	23 mm 0.91 in	23 mm 0.91 in	23 mm 0.91 in	28 mm 1.1 in
Teinte Glass color	○ Extra Blanc Extra White Flint	○ Extra Blanc Extra White Flint	○ Extra Blanc Extra White Flint	○ Extra Blanc Extra White Flint

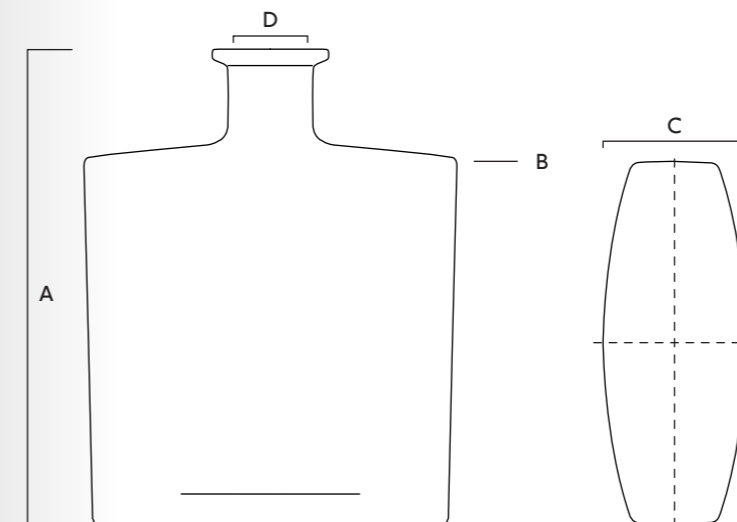

Modèle déposé « Design Saverglass »
Registered "Design Saverglass"



JIM révèle une silhouette remarquable, au large facing encadré de côtés légèrement convexes et d'une base évasée qui contribuent à tempérer cette stature géométrique, éminemment puissante et compacte. Les épaisseurs et l'éclat du verre révèlent des lignes pures et signent une carafe de caractère.

JIM boasts a remarkable silhouette, with a wide label panel framed by slightly convex sides and a flared base that help to temper its eminently powerful and compact geometric stature. The thickness and brightness of the glass expose clean lines and it distinguishes itself as a decanter with character.



Contenance
Capacity

70 cl
23.67 oz

75 cl
25.36 oz

Référence
Reference

3750

3774

Bague
Finish



Poids
Weight

1000 g
35.27 oz

1000 g
35.27 oz

Hauteur
totale [A]
Overall
height

179,5 mm
7.07 in

179,5 mm
7.07 in

Section
maxi [B]
Maxi
section

153 mm
6.02 in

153 mm
6.02 in

Épaisseur
maxi [C]
Maxi
thickness

59,2 mm
2.33 in

61,9 mm
2.44 in

Diamètre de
débouchage
[D] Entrance
bore diameter

23 mm
0.91 in

23 mm
0.91 in

Teinte
Glass color

○ Extra Blanc
Extra White Flint

○ Extra Blanc
Extra White Flint

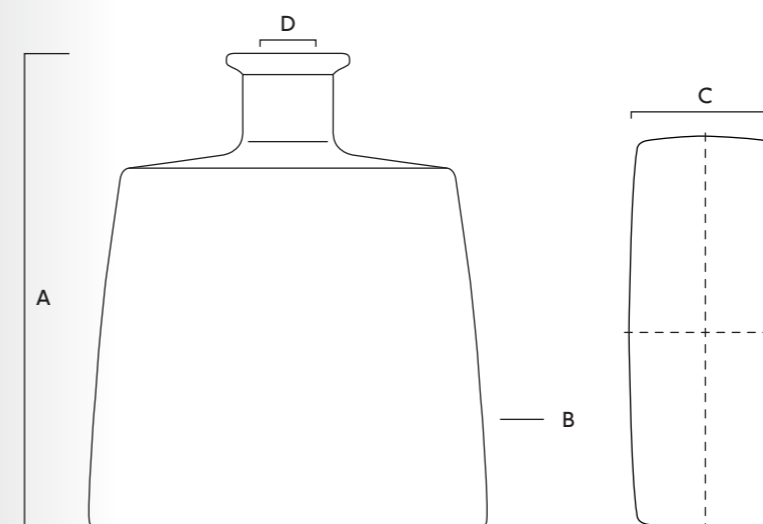

Modèle déposé « Design Saverglass »
Registered "Design Saverglass"

JULES

EXTRA PREMIUM

58 | 59



JULES réinvente hardiment les codes des écrins traditionnels des grands alcools. Ici, lignes tendues, angles aux arêtes vives, larges épaules horizontales et un imposant facing jouent une partition rupturiste. Ce parti-pris audacieux reste toutefois dans l'épure, énonçant une esthétique très masculine.

JULES boldly reinvents the codes of traditional backdrops for great spirits. On this bottle, taut lines, sharp angles, wide level shoulders, and an impressive label panel break the mold and follow their own rules. This daring stance continues in the outline, revealing a very masculine esthetic.



Contenance
Capacity

70 cl
23.67 oz

75 cl
23.67 oz

Référence
Reference

3749

3773

Bague
Finish



Carnette

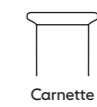

Carnette

Poids
Weight

1000 g
35.27 oz

1000 g
35.27 oz

Hauteur
totale [A]
Overall
height

209,2 mm
8.24 in

209,2 mm
8.24 in

Section
maxi [B]
Maxi
section

133,1 mm
5.24 in

133,1 mm
5.24 in

Épaisseur
maxi [C]
Maxi
thickness

56,7 mm
2.33 in

59,4 mm
2.34 in

Diamètre de
débouchage
[D] Entrance
bore diameter

23 mm
0.91 in

23 mm
0.91 in

Teinte
Glass color

○ Extra Blanc
Extra White Flint

○ Extra Blanc
Extra White Flint

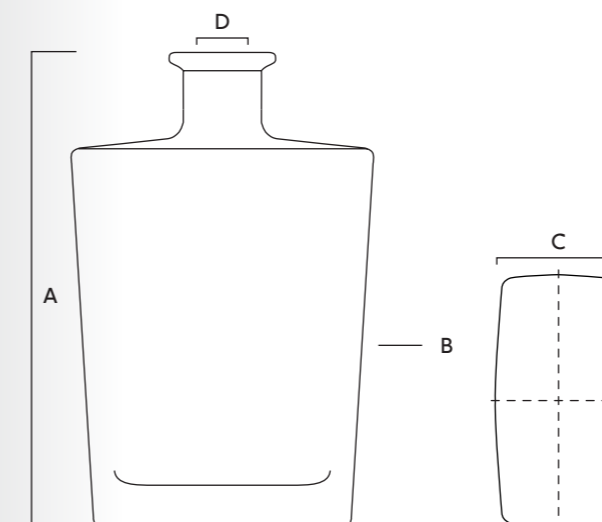

Modèle déposé « Design Saverglass »
Registered "Design Saverglass"

KHEOPS

EXTRA PREMIUM

60 | 61



Caractérisé par des lignes franches et précises, KHEOPS affiche un design de tradition classique réinterprété: des épaules larges viriles, un facing imposant, un corps conique et galbé et une base affinée dotée d'une épaisse ceinture de verre. L'ensemble offre un contenant structuré conciliant sobriété et robustesse.

Characterized by clear and precise lines, KHEOPS is a reinterpretation of a classic design: broad sturdy shoulders, bold label panel, curved tapered body, and a refined thick glass base. Taken as a whole, it showcases a structured container that reconciles simplicity and robustness.



Contenance
Capacity

70 cl
23.67 oz

75 cl
25.36 oz

Référence
Reference

2124

2222

Bague
Finish

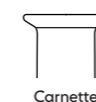

Carnette

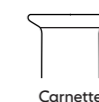

Carnette

Poids
Weight

900 g
31.75 oz

934 g
32.95 oz

Hauteur
totale [A]
Overall
height

206,3 mm
8.12 in

206,3 mm
8.12 in

Section
maxi [B]
Maxi
section

145,3 mm
5.72 in

145,3 mm
5.72 in

Épaisseur
maxi [C]
Maxi
thickness

71 mm
2.8 in

75,2 mm
2.96 in

Diamètre de
débouchage
[D] Entrance
bore diameter

23 mm
0.91 in

23 mm
0.91 in

Teinte
Glass color

○ Extra Blanc
Extra White Flint

○ Extra Blanc
Extra White Flint

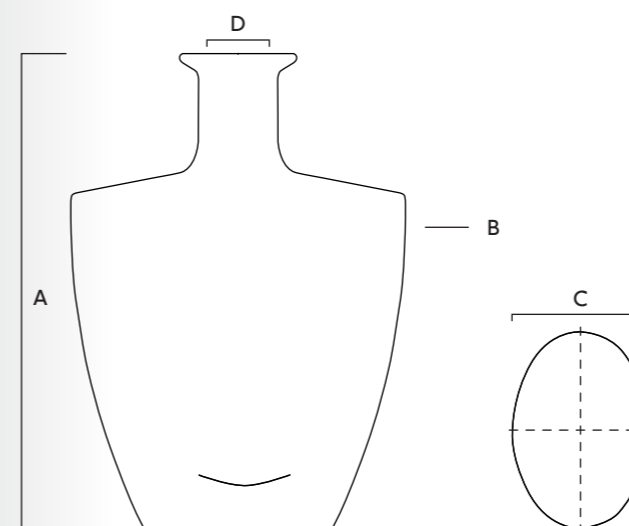

Modèle déposé « Design Saverglass »
Registered "Design Saverglass"

MADRAS

EXTRA PREMIUM

62 | 63



MADRAS, la callipyge, séduit par ses lignes douces, opulentes et sensuelles. De nature généreuse et rassurante, c'est grâce à un large facing oval et à une belle semelle de verre que s'exprime la féminité presque exacerbée de la plantureuse MADRAS.

The curvaceous MADRAS charms with its soft, opulent and sensual lines. Generous and reassuring in nature, the bottle's wide oval label panel and beautiful glass base showcase the almost exaggerated femininity of the voluptuous MADRAS.



Contenance
Capacity

70 cl
23.67 oz

Référence
Reference

3216

Bague
Finish



Carnette

Poids
Weight

900 g
31.75 oz

Hauteur
totale [A]
Overall
height

178,8 mm
7.04 in

Section
maxi [B]
Maxi
section

185 mm
7.28 in

Épaisseur
maxi [C]
Maxi
thickness

72,5 mm
2.85 in

Diamètre de
débouchage
[D] Entrance
bore diameter

23 mm
0.91 in

Teinte
Glass color

○ Extra Blanc
Extra White Flint

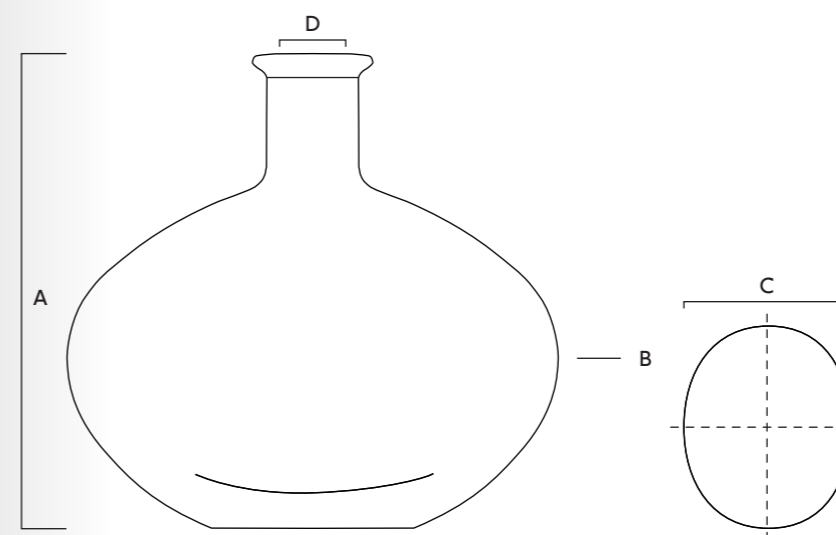

Modèle déposé « Design Saverglass »
Registered "Design Saverglass"



OLYMPE marque les esprits par cette esthétique contemporaine et épurée qui réinterprète à merveille la forme emblématique de l'amphore grecque. Son épaisse semelle de verre associée à la douceur de ses courbes confèrent à ce flacon l'élégance. Enfin, sa finesse facilite la préhension et conclut une opération séduction parfaitement exécutée.

OLYMPE is a real eye-catcher with its contemporary and refined esthetic that beautifully reinterprets the iconic shape of the Greek amphora. Its thick glass base combined with the softness of its curves make this bottle elegant. Its refined shape makes it easy to grip and rounds off its flawless efforts to charm.



Contenance
Capacity

70 cl
23.67 oz

75 cl
25.36 oz

Référence
Reference

2123

2292

Bague
Finish



Carnette



Carnette

Poids
Weight

850 g
29.98 oz

850 g
29.98 oz

Hauteur
totale [A]
Overall
height

222,7 mm
8.77 in

222,7 mm
8.77 in

Section
maxi [B]
Maxi
section

125,5 mm
4.94 in

125,5 mm
4.94 in

Épaisseur
maxi [C]
Maxi
thickness

76,4 mm
3.01 in

79,2 mm
3.12 in

Diamètre de
débouchage
[D] Entrance
bore diameter

23 mm
0.91 in

23 mm
0.91 in

Teinte
Glass color

○ Extra Blanc
Extra White Flint

○ Extra Blanc
Extra White Flint

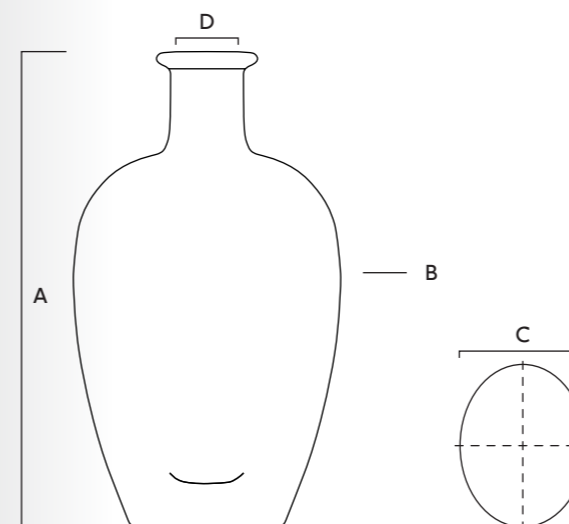

Modèle déposé « Design Saverglass »
Registered "Design Saverglass"



SCOTT ravive l'esprit de la carafe d'antan et revisite cet héritage dans un élan de modernité! Alcools bruns ou blancs s'exprimeront parfaitement dans ce flacon haut de gamme à section ronde, surmonté d'un col haut, fier et long. Empreint d'une tradition soigneusement stylisée, ce design fort sert admirablement les grandes maisons et marques de caractère.

SCOTT revives the spirit of classic decanters and revisits their legacy with a contemporary twist. Dark and clear spirits will be perfectly presented in this premium bottle featuring a round cross-section and crowned with a tall, long and prominent neck. Imbued with a carefully crafted traditional style, this strong design successfully serves large distilleries and distinguished brands.



Contenance
Capacity

70 cl
23.67 oz

75 cl
25.36 oz

Référence
Reference

2345

2385

Bague
Finish

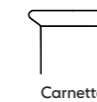

Carnette

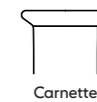

Carnette

Poids
Weight

915 g
32.28 oz

915 g
32.28 oz

Hauteur
totale [A]
Overall
height

157 mm
6.18 in

157 mm
6.18 in

Section
maxi [B]
Maxi
section

134,2 mm
5.28 in

137,2 mm
5.4 in

Diamètre de
débouchage
[D] Entrance
bore diameter

21,5 mm
0,85 in

21,5 mm
0,85 in

Teinte
Glass color

○ Extra Blanc
Extra White Flint

○ Extra Blanc
Extra White Flint

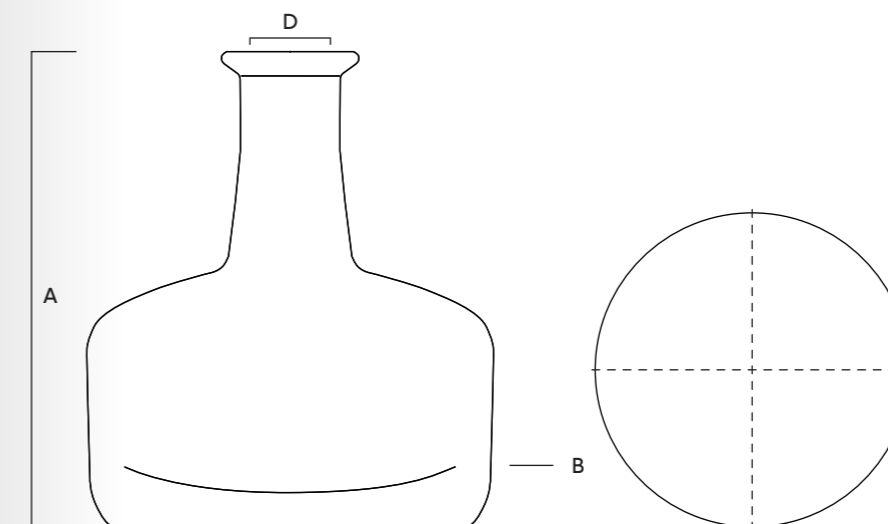

Modèle déposé « Design Saverglass »
Registered "Design Saverglass"



YOGI présente une silhouette aux dimensions exceptionnelles composé d'un facing extra-plat rectangulaire étiré et un profil extra-fin. Ses angles arrondis, sa base délicatement évasée et son épaisseur semelle de verre à la répartition très singulière signent un design aérien très contemporain. Cette carafe hors norme, est disponible en format 50 cl, et offre un formidable territoire d'expression pour toutes formes de personnalisation.

YOGI has a silhouette of exceptional size, comprising an extra-flat elongated rectangular label panel and an extra-thin profile. Its rounded contours combined with its delicately flared and thick glass base with unique spread embody an ultra-modern light and airy design. This unusual decanter is available in a 50 cl capacity and offers a large blank canvas for any kind of customization.



Contenance Capacity	50 cl 16.91 oz	70 cl 23.67 oz	75 cl 25.36 oz
Référence Reference	4292	4396	4397
Bague Finish	 Carnette	 Carnette	 Carnette
Poids Weight	860 g 30.34 oz	1160 g 40.92 oz	1175 g 41.45 oz
Hauteur totale [A] Overall height	160,3 mm 6.31 in	185,7 mm 7.31 in	185,7 mm 7.31 in
Section maxi [B] Maxi section	175 mm 6.89 in	188 mm 7.4 in	188 mm 7.4 in
Épaisseur maxi [C] Maxi thickness	55,7 mm 2.19 in	60 mm 2.36 in	62,5 mm 2.46 in
Diamètre de débouchage [D] Entrance bore diameter	23 mm 0.91 in	23 mm 0.91 in	23 mm 0.91 in
Teinte Glass color	○ Extra Blanc Extra White Flint	○ Extra Blanc Extra White Flint	○ Extra Blanc Extra White Flint

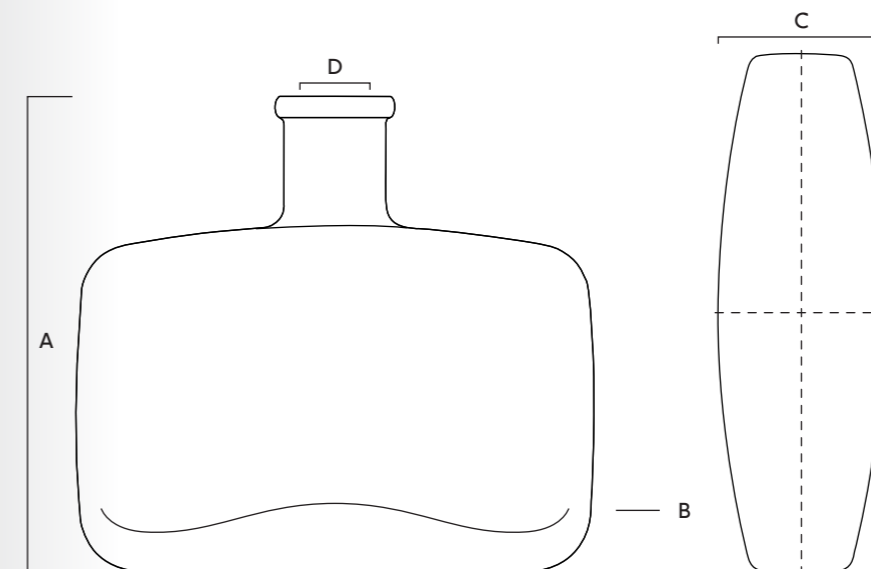



Modèle déposé « Design Saverglass »
Registered "Design Saverglass"



Doté de courbes douces rappelant les codes originels d'un flacon traditionnel de Tequila, AROME se distingue par un épaulement généreux, ponctué d'une semelle en rétreint qui souligne sa silhouette féminine. Ce design très actuel s'exprime à travers une section ovale et un fût conique surmonté d'un col droit et d'une bague à carnette.

Featuring soft curves reminiscent of the original codes of traditional tequila bottles, AROME stands out from the crowd with its generous shoulder that is punctuated by tapering around the base, emphasizing its feminine silhouette. This cutting-edge design can be seen in the bottle's oval cross-section and tapered body crowned with a straight neck and carnette finish.



Contenance Capacity	70 cl 23.67 oz	75 cl 25.36 oz
Référence Reference	5046	5047
Bague Finish	 Carnette	 Carnette
Poids Weight	780 g 27.51 oz	780 g 27.51 oz
Hauteur totale [A] Overall height	196,6 mm 7.74 in	196,6 mm 7.74 in
Section maxi [B] Maxi section	124,1 mm 4.89 in	124,1 mm 4.89 in
Épaisseur maxi [C] Maxi thickness	74,9 mm 2.95 in	79,2 mm 3.12 in
Diamètre de débouchage [D] Entrance bore diameter	21,5 mm 0,85 in	21,5 mm 0,85 in
Teinte Glass color	○ Extra Blanc Extra White Flint	○ Extra Blanc Extra White Flint

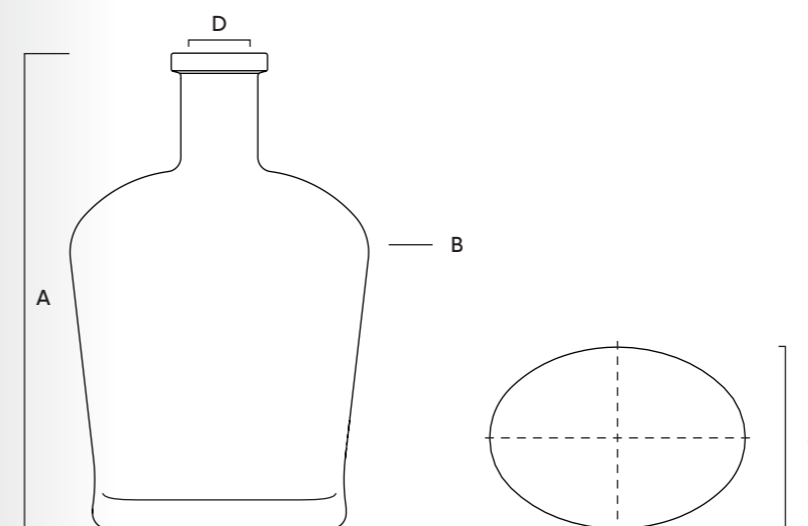

Modèle déposé « Design Saverglass »
Registered "Design Saverglass"

ATHENA



SUPER PREMIUM



Le design rigoureux d'ATHENA impressionne immédiatement par sa stature, sa dimension mythique et classique. De section rectangulaire et dotée d'une semelle de verre plate, ses facettes irradiant la lumière pour magnifier les alcools les plus exclusifs.

ATHENA's robust design is immediately striking with its stature and its mythical and classical features. With a rectangular cross-section and a flat glass base, its sides radiate light to add luster to the most exclusive spirits.



Contenance Capacity	70 cl 23.67 oz	75 cl 25.36 oz
Référence Reference	1877	1974
Bague Finish	 Carnette	 Carnette
Poids Weight	750 g 26.46 oz	750 g 26.46 oz
Hauteur totale [A] Overall height	195 mm 7.68 in	195 mm 7.68 in
Section maxi [B] Maxi section	121,7 mm 4.79 in	122,3 mm 4.81 in
Épaisseur maxi [C] Maxi thickness	67,5 mm 2.66 in	69,5 mm 2.74 in
Diamètre de débouchage [D] Entrance bore diameter	23 mm 0.91 in	23 mm 0.91 in
Teinte Glass color	○ Extra Blanc Extra White Flint	○ Extra Blanc Extra White Flint

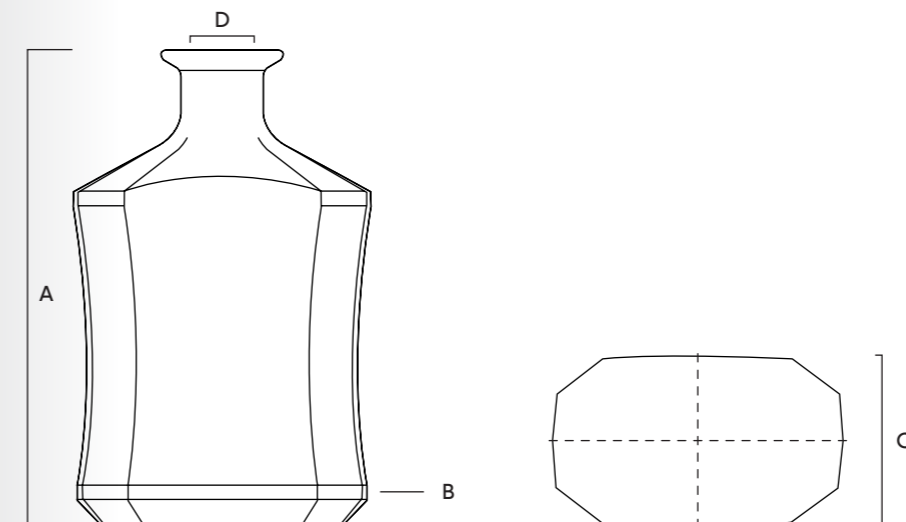

Modèle déposé « Design Saverglass »
Registered "Design Saverglass"



Caractérisée par ses contours souples, DANAÏ offre un design pur et intemporel et ouvre le champ à de multiples procédés de parachèvement. Par ses traits nets et ses courbes douces, cette carafe haute souligne en toute discrétion les alcools les plus élégants.

Characterized by smooth edges, DANAÏ showcases a clean and timeless design and opens up the scope for multiple finishing processes. With its distinct features and soft curves, this tall decanter discreetly accentuates the most sophisticated spirits.



Contenance
Capacity

70 cl
23.67 oz

Référence
Reference

3142

Bague
Finish



Plate Bouchon à tête 29

Poids
Weight

860 g
30.34 oz

Hauteur
totale [A]
Overall
height

290,5 mm
11.44 in

Section
maxi [B]
Maxi
section

115,7 mm
4.56 in

Épaisseur
maxi [C]
Maxi
thickness

70,1 mm
2.76 in

Diamètre de
débouchage
[D] Entrance
bore diameter

18,5 mm
0.73 in

Teinte
Glass color

○ Extra Blanc
Extra White Flint

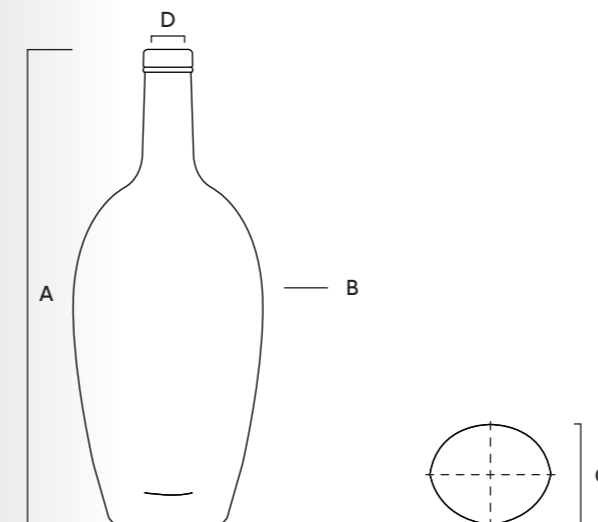

DIVA

SUPER PREMIUM

76 | 77



Née de l'hybridation heureuse entre une bouteille raffinée et une carafe aux contours harmonieux, DIVA offre une modularité exemplaire. Ce contenant de forme haute dispose en effet de remarquables qualités fonctionnelles qui lui concèdent une grande facilité de bouchage ainsi que d'innombrables options d'habillage ou de parachèvement.

Created by successfully fusing together an elegant bottle and a curvaceous decanter, DIVA offers exemplary versatility. In fact, this tall container has remarkable functional qualities, which make it easy to cork and give it countless options for decoration or finishing.



Contenance
Capacity

70 cl
23.67 oz

75 cl
25.36 oz

Référence
Reference

2308

2309

Bague
Finish



Poids
Weight

850 g
29.98 oz

850 g
29.98 oz

Hauteur
totale [A]
Overall
height

283 mm
11.14 in

283 mm
11.14 in

Section
maxi [B]
Maxi
section

109,3 mm
4.3 in

109,3 mm
4.3 in

Épaisseur
maxi [C]
Maxi
thickness

69,1 mm
2.72 in

71,8 mm
2.83 in

Diamètre de
débouchage
[D] Entrance
bore diameter

18,5 mm
0.73 in

18,5 mm
0.73 in

Teinte
Glass color

○ Extra Blanc
Extra White Flint

○ Extra Blanc
Extra White Flint

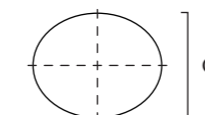
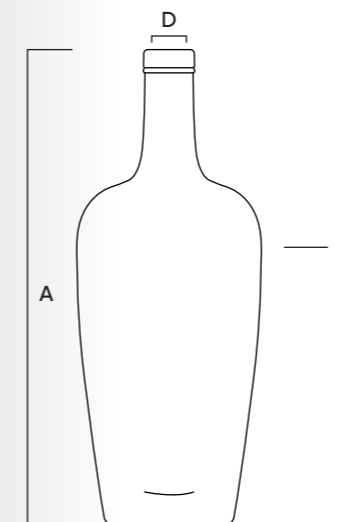

Modèle déposé « Design Saverglass »
Registered "Design Saverglass"

ELLIPTIC

SUPER PREMIUM

78 | 79



Carafe à la personnalité affirmée, ELLIPTIC se caractérise par des épaules légèrement saillantes, un facing généreux, et l'équilibre des proportions. Traitée tout en légèreté, grâce à son poids raisonnable, elle symbolise le compromis idéal entre forme recherchée, praticité et compétitivité et saura magnifier tous types d'alcools, bruns ou blancs, grâce à un col droit surmonté d'une bague plate conique.

ELLIPTIC is a decanter with a distinct personality, characterized by gently protruding shoulders, a generous label panel, and balanced proportions. Easy to handle thanks to its moderate weight, it symbolizes the perfect balance between refinement, practicality and competitiveness and will accentuate all types of spirits, whether dark or clear, thanks to a straight neck crowned by a flat tapered finish.



Contenance
Capacity

70 cl
23.67 oz

75 cl
25.36 oz

Référence
Reference

5378

5379

Bague
Finish

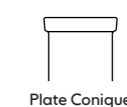
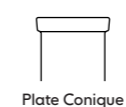

Poids
Weight

750 g
26.46 oz

750 g
26.46 oz

Hauteur
totale [A]
Overall
height

192 mm
7.56 in

192 mm
7.56 in

Section
maxi [B]
Maxi
section

129 mm
5.08 in

129 mm
5.08 in

Épaisseur
maxi [C]
Maxi
thickness

83,1 mm
3.27 in

86,4 mm
3.4 in

Diamètre de
débouchage
[D] Entrance
bore diameter

23 mm
0.91 in

23 mm
0.91 in

Teinte
Glass color

○ Extra Blanc
Extra White Flint

○ Extra Blanc
Extra White Flint

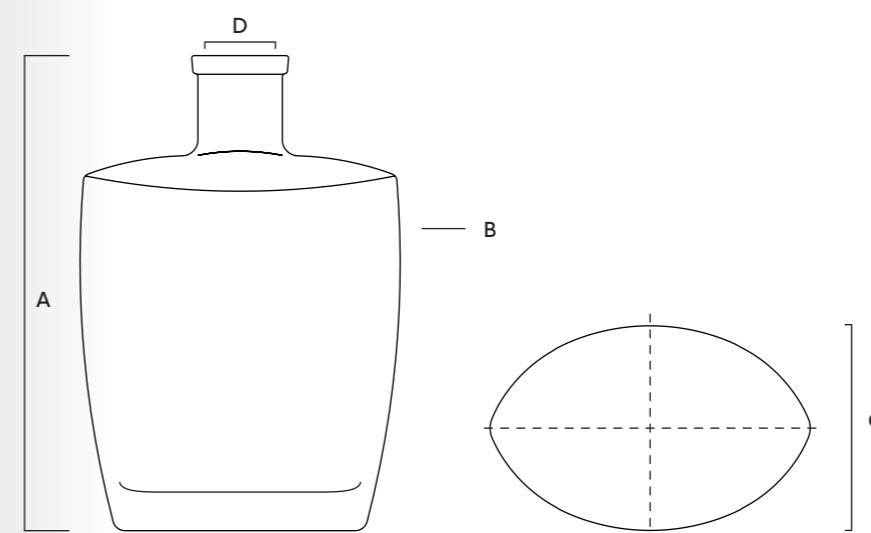

Modèle déposé « Design Saverglass »
Registered "Design Saverglass"



Rythmée par ces facettes et dotée d'une épaisse semelle de verre, PRINCE doit son allure royale et sa silhouette équilibrée à son imposante section carrée. Un design classique aux accents luxueux qui met en lumière les alcools les plus nobles.

Shaped by its side panels and featuring a thick glass base, PRINCE owes its royal appearance and well-balanced silhouette to its impressive square cross-section. It features a classic design with luxurious accents that add luster to the finest spirits.



Contenance
Capacity

70 cl
23.67 oz

75 cl
25.36 oz

Référence
Reference

1515

1871

Bague
Finish

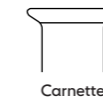

Carnette

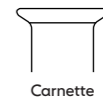

Carnette

Poids
Weight

800 g
28.22 oz

820 g
28.92 oz

Hauteur
totale [A]
Overall
height

185 mm
7.28 in

185 mm
7.28 in

Section
maxi [B]
Maxi
section

105,7 mm
4.16 in

108,4 mm
4.27 in

Épaisseur
maxi [C]
Maxi
thickness

93,3 mm
3.67 in

95,5 mm
3.76 in

Diamètre de
débouchage
[D] Entrance
bore diameter

23 mm
0.91 in

23 mm
0.91 in

Teinte
Glass color

○ Extra Blanc
Extra White Flint

○ Extra Blanc
Extra White Flint

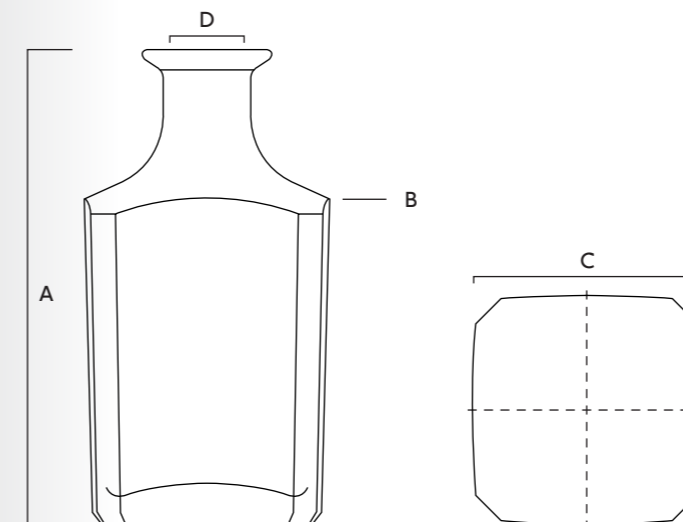

Modèle déposé « Design Saverglass »
Registered "Design Saverglass"



L'intemporelle ZENITH s'impose comme un classique indémodable. Sa section carrée rehaussée d'une bague à carnette et ses larges surfaces planes facilement exploitables pour la personnalisation définissent les attributs d'une valeur sûre.

The timeless ZENITH establishes itself as a classic that's always in fashion. Its square cross-section is crowned by a carnette finish and features large flat panels that can be easily customized, a combination that defines what makes a surefire classic.



Contenance
Capacity

70 cl
23.67 oz

75 cl
25.36 oz

Référence
Reference

1134

1107

Bague
Finish

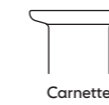

Carnette

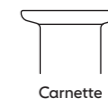

Carnette

Poids
Weight

800 g
28.22 oz

800 g
28.22 oz

Hauteur
totale [A]
Overall
height

169 mm
6.65 in

169 mm
6.65 in

Section
maxi [B]
Maxi
section

95,5 mm
3.76 in

98 mm
3.86 in

Épaisseur
maxi [C]
Maxi
thickness

95,5 mm
3.76 in

98 mm
3.86 in

Diamètre de
débouchage
[D] Entrance
bore diameter

23 mm
0.91 in

23 mm
0.91 in

Teinte
Glass color

○ Extra Blanc
Extra White Flint

○ Extra Blanc
Extra White Flint

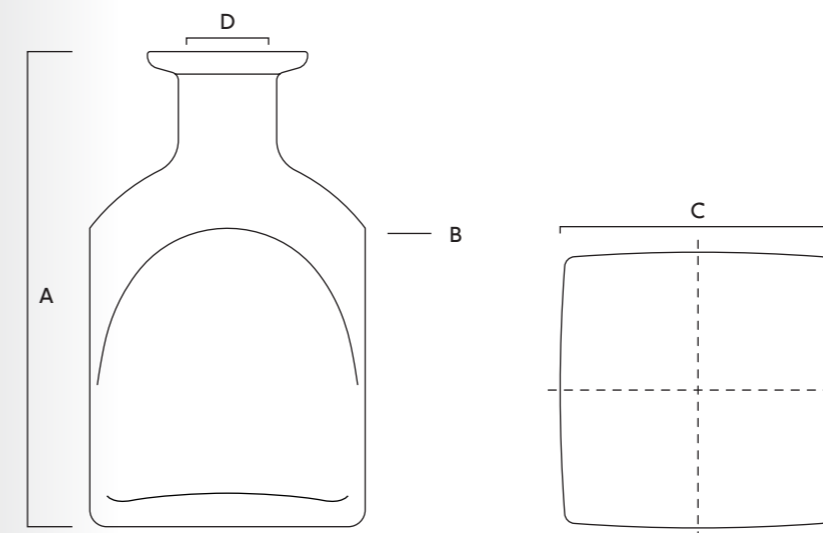

Modèle déposé « Design Saverglass »
Registered "Design Saverglass"

BO UT EILLES ES

BOTTLES

ANGLAISE	253
ARIANE 1	103
ARIANE 2	185
ATTITUDE HAUTE	90
AXEL	93
BAHIA	182
BAMBOO	232
BASQUAISE	235
BELLISSIMA	106
BOSTON	188
BOTANIC	190
BUBBLE	108
BYBLOS SPIRIT	180
CALVADOS	239
CAPTAIN HOOK	110
CEREMONY	112
CHARENNAISE	243
COGNAC	253
COGNAÇAISE	243
DIAMOND	114
DISTIL'ER	192
DYNAMITE	116
EMPIRE	118
ESSENCIA	120
EXCEPTION	122
FIDJI	125
FLAVOUR	128
FLÛTE ALTUS SPIRIT	212
FLÛTE DISTILLATEUR	249
FORTY-SIX	194
GEISHA	130
H DOZO	132
INA	214
INSOLENCIA SPIRIT	196
ISLAY	134
KENDO SPIRIT	137
KENDO SQUARE	140

KIMONO	142
LEXA	96
LITTLE PASHA	144
LITTLE SUMO	147
LONG ISLAND	151
MARC GRAND CRU	210
MARIE-LAURENCE	253
MARTINIQUE	246
MILLÉSIME (LA)	198
MIXOLOGIST	200
MIYU	154
NATHALIE	253
NEOS	157
NESS	160
NORMANDE HAUTE	239
NORMANDIE	202
NUMBER ONE	162
OSLO	165
OSLO APOTHEK	169
OXYGEN	205
PAILLARDE	243
PEARL	172
PIRATE	174
PREMIÈRE SPIRIT	180
QBIC	99
SABA	182
SINGLE	176
TAM-TAM	216
THAÏ	218
TIME SQUARE	208
TONIC	178
TSAR	220
VIRGIN	223
WHISKY STANDARD	253
WINCH	230
ZADIG	227

FORMES HAUTES TALL VERSIONS



ARIANE 1
P. 103



ARIANE 2
P. 185



ATTITUDE HAUTE
P. 90



AXEL
P. 93



BAHIA
P. 182



BAMBOO
P. 232



BELLISSIMA
P. 106



BYBLOS SPIRIT
P. 180



CALVADOS
P. 239



CEREMONY HAUTE
P. 112



COGNAÇAISE
P. 243



EMPIRE HAUTE
P. 118



ESSENCIA
P. 120



EXCEPTION
P. 122



FIDJI
P. 125



FLÛTE ALTUS SPIRIT
P. 212



FLÛTE DISTILLATEUR
P. 249



GEISHA
P. 130



H DOZO
P. 132



INSOLENCE SPIRIT
P. 196



KENDO SPIRIT
P. 137



KENDO SQUARE
P. 140



KIMONO
P. 142



MARC GRAND CRU
P. 210



LA MILLÉSIME
P. 198



NORMANDE HAUTE
P. 239



NORMANDIE
P. 202



NUMBER ONE HAUTE
P. 162



PAILLARDE
P. 243



PREMIÈRE SPIRIT
P. 180



SABA
P. 182



SINGLE
P. 176



TAM-TAM
P. 216



THAÏ
P. 218



VIRGIN
P. 223

FORMES MI-HAUTES MEDIUM VERSIONS



BOSTON
P. 188



CAPTAIN HOOK
P. 110



DIAMOND
P. 114



DISTIL'ER
P. 192



FORTY-SIX
P. 194



LEXA
P. 96



LONG ISLAND
P. 151



MARTINIQUE
P. 246



MIYU
P. 154



NESS
P. 160



OSLO APOTHEK
P. 169



OXYGEN
P. 205



PEARL
P. 172



PIRATE
P. 174



QBIC
P. 99



TONIC
P. 178

FORMES BASSES SHORT VERSIONS



BASQUAISE
P. 235



BOTANIC
P. 190



BUBBLE
P. 108



CEREMONY BASSE
P. 112



DYNAMITE
P. 116



EMPIRE BASSE
P. 118



FLAVOUR
P. 128



INA
P. 214



ISLAY
P. 134



LITTLE PASHA
P. 144



LITTLE SUMO
P. 147



MIXOLOGIST
P. 200



NEOS
P. 157



NUMBER ONE BASSE
P. 162



OSLO
P. 165



TIME SQUARE BASSE
P. 208



TSAR
P. 220



WINCH
P. 230



ZADIG
P. 227

ATTITUDE HAUTE

EXTRA PREMIUM



90 | 91



ATTITUDE «version haute» est la variante longiligne, gracile et élancée de la carafe du même nom. Ce flacon haut de gamme se caractérise par sa hauteur, sa section ovale, son facing courbe important sublimé par ce subtil jeu d'ailettes qui capte la lumière. À n'en pas douter cette carafe ne manque pas d'allure!

ATTITUDE HAUTE is the slim, sleek and slender version of the Attitude decanter. This premium bottle stands out with its height, oval cross-section, and a label panel shaped by sweeping curves and enhanced by its subtle light-catching set of flanges. There's no doubt that this decanter is brimming with style!



Contenance Capacity	70 cl 23.67 oz	75 cl 25.36 oz
Référence Reference	5036	5037
Bague Finish	 Plate SB 34	 Plate SB 34
Poids Weight	965 g 34.04 oz	965 g 34.04 oz
Hauteur totale [A] Overall height	284,30 mm 11.19 in	284,30 mm 11.19 in
Section maxi [B] Maxi section	119,8 × 58,8 mm 4.72 × 2.31 in	119,8 × 61 mm 4.72 × 2.4 in
Section mini [C] Mini section	108,9 × 54,4 mm 4.29 × 2.14 in	108,9 × 56,4 mm 4.29 × 2.22 in
Diamètre de débouchage [D] Entrance bore diameter	23 mm 0.91 in	23 mm 0.91 in
Teinte Glass color	○ Extra Blanc Extra White Flint	○ Extra Blanc Extra White Flint

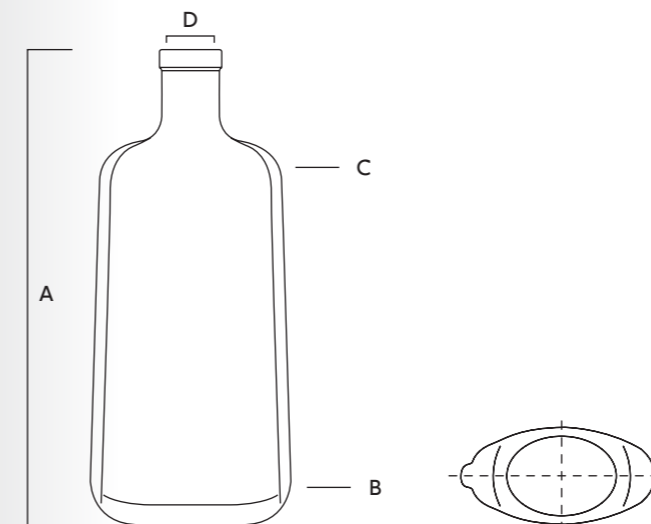

Modèle déposé « Design Saverglass »
Registered "Design Saverglass"

AXEL

EXTRA PREMIUM







AXEL, forme pure par excellence, quintessence du design géométrique entièrement maîtrisé, présente une architecture résolument contemporaine grâce à des lignes tendues, des angles vifs, un épaulement parfaitement horizontal, ainsi qu'une section rectangulaire couplée à une silhouette longiligne conique. Ses proportions impressionnantes et ses épaisseurs de verre extrêmes participent à son image moderne et à son positionnement prestigieux.

AXEL is the ultimate in clean shaping and epitome of skillful geometric design. It features a resolutely contemporary style with its taut lines, sharp angles, perfectly level shoulder, and rectangular cross-section coupled with a sleek tapered silhouette. Its impressive proportions and extreme glass thickness give the bottle its cutting-edge appearance and prestigious positioning.





AXEL

EXTRA PREMIUM

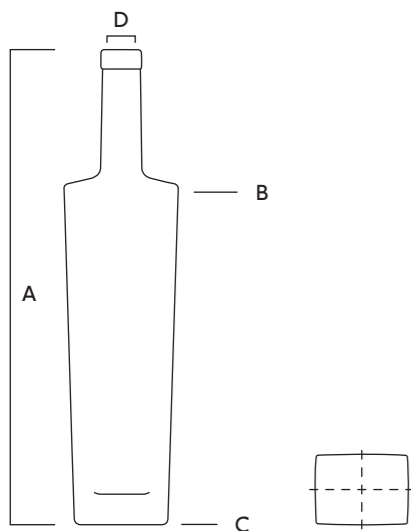

Contenance Capacity	5 cl 1.69 oz	35 cl 11.84 oz	37,5 cl 12.68 oz	50 cl 16.91 oz
Référence Reference	3765	3767	3768	3769
Bague Finish	 BVS 18 STD	 Plate Bouchon à tête 29	 Plate Bouchon à tête 29	 Plate Bouchon à tête 29
Poids Weight	122 g 4.3 oz	585 g 20.63 oz	595 g 20.99 oz	720 g 25.4 oz
Hauteur totale [A] Overall height	153,5 mm 6.04 in	282,8 mm 11.13 in	286,4 mm 11.28 in	304,3 mm 11.98 in
Section maxi [B] Maxi section	37,5 × 28,2 mm 1.48 × 1.11 in	67,5 × 50,3 mm 2.66 × 1.98 in	68,4 × 50,9 mm 2.69 × 2 in	75,2 × 56,6 mm 2.96 × 2.23 in
Section mini [C] Mini section	31,6 × 24,2 mm 1.24 × 0.95 in	56 × 42,1 mm 2.2 × 1.66 in	56,6 × 42,5 mm 2.23 × 1.67 in	63,3 × 47,6 mm 2.49 × 1.87 in
Diamètre de débouchage [D] Entrance bore diameter	10,5 mm 0.41 in	18,5 mm 0.73 in	18,5 mm 0.73 in	18,5 mm 0.73 in
Teinte Glass color	○ Extra Blanc Extra White Flint	○ Extra Blanc Extra White Flint	○ Extra Blanc Extra White Flint	○ Extra Blanc Extra White Flint





70 cl 23.67 oz	75 cl 25.36 oz	100 cl 33.82 oz	175 cl 59.18 oz
3646	3651	3771	3896
 Plate Bouchon à tête 29	 Plate Bouchon à tête 29	 Plate Bouchon à tête 34	 Plate Bouchon à tête 34
940 g 33.16 oz	960 g 33.86 oz	1260 g 44.44 oz	1895 g 66.84 oz
343 mm 13.50 in	343 mm 13.50 in	355 mm 13.98 in	425 mm 16.73 in
83 × 62 mm 3.27 × 2.44 in	85,3 × 64,3 mm 3.36 × 2.53 in	96,1 × 72,4 mm 3.78 × 2.85 in	112 × 84 mm 4.41 × 3.31 in
68 × 52 mm 2.68 × 2.05 in	70,3 × 54,3 mm 2.77 × 2.14 in	79,2 × 60,2 mm 3.12 × 2.37 in	93 × 77 mm 3.66 × 3.03 in
18,5 mm 0.73 in	18,5 mm 0.73 in	21,5 mm 0.85 in	21,5 mm 0.85 in
○ Extra Blanc Extra White Flint	○ Extra Blanc Extra White Flint	○ Extra Blanc Extra White Flint	○ Extra Blanc Extra White Flint



Une rigueur toute géométrique caractérise le design aiguisé du modèle LEXA. De section rectangulaire, la vivacité de la forme est renforcée par des angles aux arêtes nerveuses. De taille mi-haute, la bouteille est rehaussée par les fortes épaisseurs de verre qui forment la semelle et les colonnes latérales, de manière parfaitement maîtrisée.

Its strong geometric shape is a signature feature of LEXA's cutting-edge design. With a rectangular cross-section, the bottle's robust shape is further strengthened by angles with taut edges. The mid-sized bottle is enhanced by strong thick glass that firmly forms the base and side columns.



Contenance Capacity	70 cl 23.67 oz	75 cl 25.36 oz
Référence Reference	4805	4806
Bague Finish	 Plate	 Plate
Poids Weight	940 g 33.16 oz	960 g 33.86 oz
Hauteur totale [A] Overall height	280 mm 11.02 in	280 mm 11.02 in
Section maxi [B] Maxi section	88,7 × 72,7 mm 3.49 × 2.86 in	91,2 × 74,8 mm 3.59 × 2.94 in
Section mini [C] Mini section	73,7 × 62,7 mm 2.9 × 2.47 in	75,8 × 64,5 mm 2.98 × 2.54 in
Diamètre de débouchage [D] Entrance bore diameter	21,5 mm 0.85 in	21,5 mm 0.85 in
Teinte Glass color	○ Extra Blanc Extra White Flint	○ Extra Blanc Extra White Flint

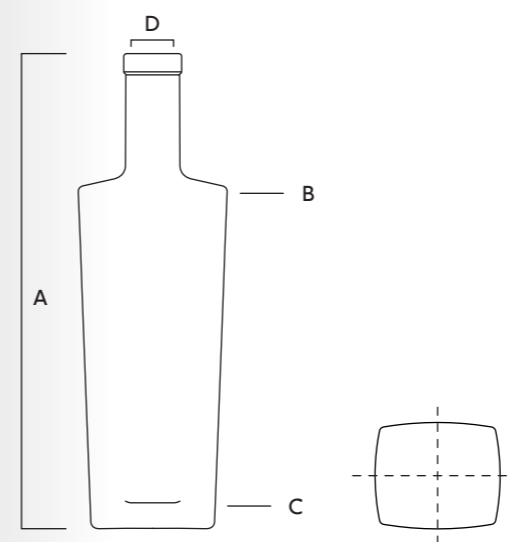

QBIC

EXTRA PREMIUM



Ludique et spectaculaire, ce modèle s'inspire du jeu de cubes: dérivés des formats totalement cubiques 35 cl, 37,5 cl et 50 cl, les capacités principales 70 cl et 75 cl reprennent les mêmes cotes de section ainsi que de belles épaisseurs de verre à l'identique (semelle et colonnes). Seule marque de différenciation: le volume qui est récupéré en l'étirant sur la hauteur. La vivacité et la puissance de QBIC, sa modernité, sont soulignées par la maîtrise du formage et la pureté du verre.

Playful and flamboyant, this model draws on cubic shapes: descending from the cube-shaped models in 35 cl, 37.5 cl and 50 cl capacities, the 70 cl and 75 cl bottles echo the same cross-section dimensions and beautiful glass thicknesses, replicating their appearance (base and columns). The only difference being the volume that is achieved by extending the bottle's height. The QBIC's robust and powerful nature and its innovativeness are emphasized by its masterful shaping and glass purity.

QBIC

EXTRA PREMIUM



Contenance Capacity	35 cl 11.84 oz	37,5 cl 12.68 oz	50 cl 16.91 oz	50 cl 16.91 oz
Référence Reference	5173	5174	3926	3926
Bague Finish	 Plate	 Plate	 Plate	 GPI 400/33
Poids Weight	630 g 22.22 oz	640 g 22.57 oz	830 g 29.28 oz	850 g 29.98 oz
Hauteur totale [A] Overall height	147,8 mm 5.82 in	147,8 mm 5.82 in	160,7 mm 6.33 in	161,9 mm 6.37 in
Section maxi [B] Maxi section	78,1 × 78,1 mm 3.07 × 3.07 in	80 × 80 mm 3.15 × 3.15 in	87,8 × 87,8 mm 3.46 × 3.46 in	87,8 × 87,8 mm 3.46 × 3.46 in
Section mini [C] Mini section	77,2 × 77,2 mm 3.04 × 3.04 in	79,1 × 79,1 mm 3.11 × 3.11 in	86,8 × 86,8 mm 3.42 × 3.42 in	86,8 × 86,8 mm 3.42 × 3.42 in
Diamètre de débouchage [D] Entrance bore diameter	21,5 mm 0.85 in	21,5 mm 0.85 in	21,5 mm 0.85 in	21,5 mm 0.85 in
Teinte Glass color	○ Extra Blanc Extra White Flint	○ Extra Blanc Extra White Flint	○ Extra Blanc Extra White Flint	○ Extra Blanc Extra White Flint

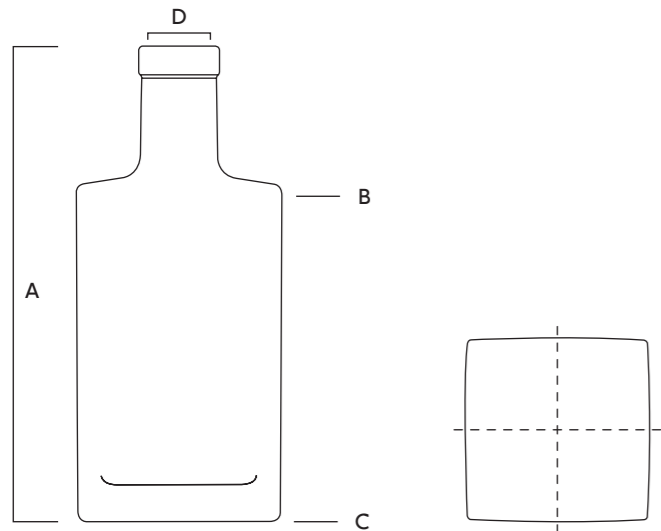

70 cl 23.67 oz	70 cl 23.67 oz	75 cl 25.36 oz	75 cl 25.36 oz	100 cl 33.82 oz
3927	3927	3928	3928	3929
 Plate	 GPI 400/33	 Plate	 GPI 400/33	 Plate
970 g 34.22 oz	985 g 34.74 oz	1010 g 35.63 oz	1010 g 35.63 oz	1210 g 42.68 oz
203,8 mm 8.02 in	205 mm 8.07 in	215,6 mm 8.49 in	216,8 mm 8.54 in	269,3 mm 10.60 in
88 × 88 mm 3.46 × 3.46 in	88 × 88 mm 3.46 × 3.46 in	88 × 88 mm 3.46 × 3.46 in	88 × 88 mm 3.46 × 3.46 in	88,3 × 88,3 mm 3.48 × 3.48 in
86,8 × 86,8 mm 3.42 × 3.42 in	86,8 × 86,8 mm 3.42 × 3.42 in	86,8 × 86,8 mm 3.42 × 3.42 in	86,8 × 86,8 mm 3.42 × 3.42 in	86,8 × 86,8 mm 3.42 × 3.42 in
21,5 mm 0.85 in	21,5 mm 0.85 in	21,5 mm 0.85 in	21,5 mm 0.85 in	21,5 mm 0.85 in
○ Extra Blanc Extra White Flint	○ Extra Blanc Extra White Flint	○ Extra Blanc Extra White Flint	○ Extra Blanc Extra White Flint	○ Extra Blanc Extra White Flint

ARIANE 1

SUPER PREMIUM



Modèle iconique par excellence, ARIANE 1 s'impose comme un incontournable du catalogue Saverglass. Son succès s'explique par la pureté de sa ligne et sa forme ronde, sa haute stature, son épaisse semelle de verre et son long col fin très apprécié des bar-tenders. L'équilibre de ses proportions participe avantageusement à l'intemporalité du modèle, mais aussi à sa modernité. Le modèle dispose d'une belle profondeur de gamme répondant ainsi aux développements multi-marchés des marques qui la choisissent.

The ultimate icon, ARIANE 1 has established itself a must-have in the Saverglass catalog. The bottle's success is down to its clean lines and round shape, its high stature, thick glass base and slender long neck, which is very popular among bartenders. Its balanced proportions add to the model's timelessness while helping it to stay fresh. The model boasts an extensive range, allowing it to respond to the multi-market developments of brands that choose to use it for their products.

ARIANE 1

SUPER PREMIUM

Contenance Capacity	5 cl 1.69 oz	10 cl 3.38 oz	20 cl 6.76 oz	35 cl 11.84 oz	37.5 cl 12.68 oz	50 cl 16.91 oz	70 cl 23.67 oz
Référence Reference	2175	2355	2176	2177	2306	2178	2144
Bague Finish	 BVP 18 STD	 BVP 22 STD SP	 Plate Bouchon à tête 23	 Plate Bouchon à tête 27	 Plate Bouchon à tête 27	 Plate Bouchon à tête 27	 Plate Bouchon à tête 29
Poids Weight	88 g 3.1 oz	170 g 6.00 oz	300 g 10.58 oz	450 g 15.87 oz	450 g 15.87 oz	600 g 21.16 oz	800 g 28.22 oz
Hauteur totale [A] Overall height	137,3 mm 5.41 in	184,7 mm 7.27 in	223 mm 8.78 in	267 mm 10.51 in	267 mm 10.51 in	295,8 mm 11.65 in	329,5 mm 12.97 in
Section maxi [B] Maxi section	34,2 mm 1.35 in	40,4 mm 1.59 in	50,6 mm 1.99 in	59,6 mm 2.35 in	61 mm 2.4 in	66,9 mm 2.63 in	74,5 mm 2.93 in
Diamètre de débouchage [D] Entrance bore diameter	10,5 mm 0.41 in	14 mm 0.55 in	15,5 mm 0.61 in	17,5 mm 0.69 in	17,5 mm 0.69 in	17,5 mm 0.69 in	18,5 mm 0.73 in
Teinte Glass color	○ Extra Blanc Extra White Flint	○ Extra Blanc Extra White Flint	○ Extra Blanc Extra White Flint	○ Extra Blanc Extra White Flint	○ Extra Blanc Extra White Flint	○ Extra Blanc Extra White Flint	○ Extra Blanc Extra White Flint

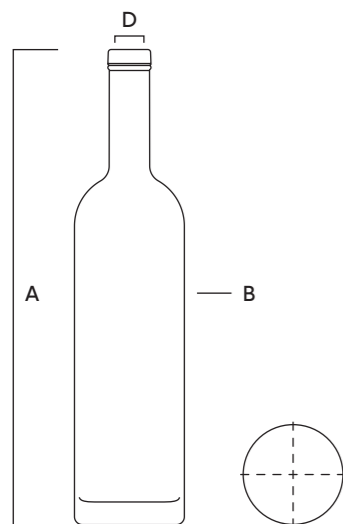

75 cl 25.36 oz	100 cl 33.82 oz	150 cl 50.73 oz	175 cl 59.18 oz	300 cl 101.45 oz	450 cl 152.18 oz
2179	3275	2181	2391	3067	3811
 Plate Bouchon à tête 29	 Plate Bouchon à tête 29	 Plate Bouchon à tête 34	 Plate Bouchon à tête 34	 Plate Bouchon à tête 43	 Plate Bouchon à tête 46
800 g 28.22 oz	900 g 31.75 oz	1340 g 47.27 oz	1376 g 48.54 oz	2550 g 89.95 oz	2800 g 98.77 oz
329,5 mm 12.97 in	346 mm 13.62 in	418 mm 16.46 in	418 mm 16.46 in	523,3 mm 20.60 in	557 mm 21.93 in
76,5 mm 3.01 in	84,5 mm 3.33 in	94,1 mm 3.7 in	100,6 mm 3.96 in	117,9 mm 4.64 in	135,7 mm 5.34 in
18,5 mm 0.73 in	18,5 mm 0.73 in	21,5 mm 0.85 in	21,5 mm 0.85 in	23 mm 0.91 in	28 mm 1.1 in
○ Extra Blanc Extra White Flint	○ Extra Blanc Extra White Flint	○ Extra Blanc Extra White Flint	○ Extra Blanc Extra White Flint	○ Extra Blanc Extra White Flint	○ Extra Blanc Extra White Flint

BELLISSIMA

SUPER PREMIUM

106 | 107



Svelte, longiligne et versatile, BELLISSIMA attire sans conteste tous les regards. Son design graphique très actuel, mais aussi très pur, à la stature impressionnante, se caractérise par un col particulièrement haut et un long fût cylindrique. De plus, la diversité des contenances disponibles dans cette gamme permet toutes les utilisations.

Slender, sleek and versatile, BELLISSIMA is hands down the greatest head-turner. Its visual design is cutting-edge but very simple, featuring an impressive stature marked by an exceptionally high neck and a long cylindrical body. In addition, this model is extremely versatile with its wide range of available capacities.



Contenance Capacity	20 cl 6.76 oz	35 cl 11.84 oz	37.5 cl 12.68 oz	50 cl 16.91 oz	75 cl 25.36 oz	150 cl 50.73 oz
Référence Reference	3693	1783	1782	1717	1718	2397
Bague Finish	 Plate	 Plate	 Plate	 Plate	 Plate	 Plate
Poids Weight	470 g 16.58 oz	505 g 17.81 oz	510 g 17.99 oz	665 g 23.46 oz	725 g 25.57 oz	1300 g 45.86 oz
Hauteur totale [A] Overall height	276,2 mm 10.87 in	331 mm 13.03 in	331 mm 13.03 in	352 mm 13.86 in	352 mm 13.86 in	480 mm 18.90 in
Section maxi [B] Maxi section	49,7 mm 1.96 in	54,4 mm 2.14 in	55,8 mm 2.2 in	62,6 mm 2.46 in	73,8 mm 2.91 in	87 mm 3.43 in
Diamètre de débouchage [D] Entrance bore diameter	18,5 mm 0.73 in	18,5 mm 0.73 in	18,5 mm 0.73 in	18,5 mm 0.73 in	18,5 mm 0.73 in	21,5 mm 0.85 in
Teinte Glass color	○ Extra Blanc Extra White Flint	○ Extra Blanc Extra White Flint	○ Extra Blanc Extra White Flint	○ Extra Blanc Extra White Flint	○ Extra Blanc Extra White Flint	○ Extra Blanc Extra White Flint

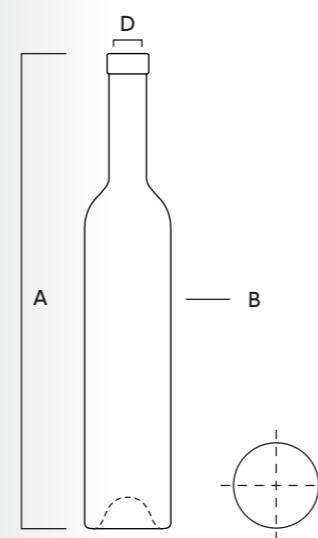

Modèle déposé « Design Saverglass »
Registered "Design Saverglass"

BUBBLE

SUPER PREMIUM



108 | 109



Épurée à l'extrême dans ses moindres détails, son corps parfaitement sphérique est chahuté par un plan de pose net, lui-même agrémenté d'un bombage conçu pour la personnalisation. Son épaule douce surmontée d'un col conique et d'une bague carnette vive contribuent à l'allure luxueuse et ludique du flacon. BUBBLE: l'écrin pour spiritueux haut de gamme en quête de rond absolu!

Exceptionally refined down to the smallest details, its perfectly spherical body is accentuated by its clean design, complemented by a curvaceous body designed for customization. Its soft shoulder crowned with a tapered neck and bold carnette finish add to the bottle's luxurious and playful appearance. BUBBLE: the backdrop for premium spirits seeking a perfect voluptuous figure!



Contenance Capacity	70 cl 23.67 oz	75 cl 25.36 oz
Référence Reference	6123	6184
Bague Finish	 Carnette	 Carnette
Poids Weight	855 g 30.16 oz	860 g 30.34 oz
Hauteur totale [A] Overall height	169,1 mm 6.66 in	169,1 mm 6.66 in
Section maxi [B] Maxi section	124,8 mm 4.91 in	128,3 mm 5.05 in
Diamètre de débouchage [D] Entrance bore diameter	23 mm 0.91 in	23 mm 0.91 in
Teinte Glass color	○ Extra Blanc Extra White Flint	○ Extra Blanc Extra White Flint

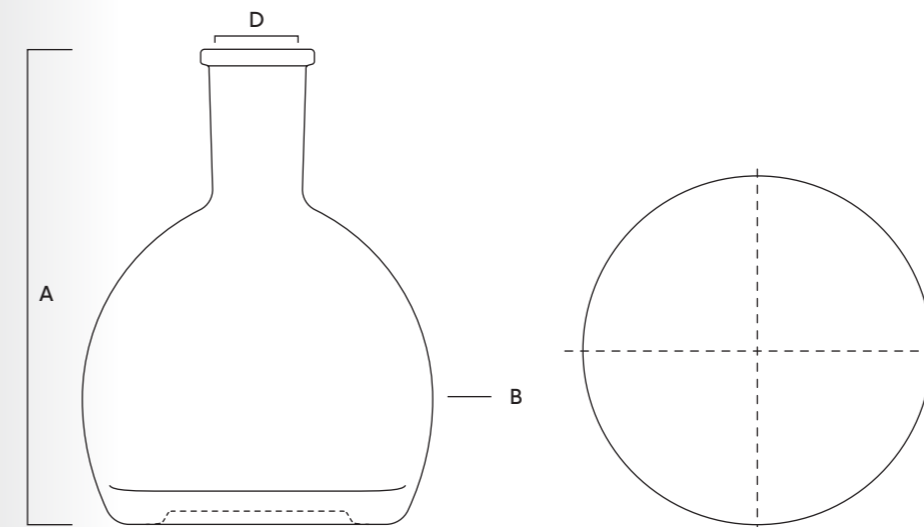

Modèle déposé « Design Saverglass »
Registered "Design Saverglass"

CAPTAIN HOOK

SUPER PREMIUM





110 | 111



S'il est bien un alcool que l'on associe volontiers à l'univers des pirates, c'est bien le rhum. Magnifiant les nuances ambrées de ces eaux-de-vie, CAPTAIN HOOK s'impose par son design tout en équilibre. Ce flacon, composé d'une section ronde, d'un corps conique, d'un épaulement généreux et d'une anse élégante parfaitement dessinée, est reliée à un col conique, lui aussi. La bague carnette plate et vive, à deux niveaux, fait écho à la piqûre en escalier logée au milieu de la semelle: deux marches bien distinctes qui permettent au liquide de se refléter doublement. Autant d'éléments «signature» d'un design fort, résolument haut de gamme.

If there's one spirit that we immediately associate with the pirating world, it's rum. CAPTAIN HOOK accentuates the amber shades of these rich spirits and stands out with its perfectly balanced design. This bottle comprises a round cross-section, tapered body, generous shoulder, and an exquisitely shaped and elegant handle attached to a tapered neck. The bold flat two-tiered carnette finish mirrors the stepped punt in the middle of the base: two distinct tiers that reflect the liquid twofold. This bottle showcases many signature features of a strong, decidedly premium design.



Contenance Capacity	70 cl 23.67 oz	70 cl 23.67 oz	75 cl 25.36 oz	75 cl 25.36 oz
Référence Reference	5822	5822	5864	5864
Bague Finish	 Carnette	 GPI 400/33	 Carnette	 GPI 400/33
Poids Weight	911 g 32.13 oz	920 g 32.45 oz	910 g 32.1 oz	915 g 32.28 oz
Hauteur totale [A] Overall height	223,7 mm 8.81 in	234,4 mm 9.23 in	223,7 mm 8.81 in	234,4 mm 9.23 in
Section maxi [B] Maxi section	96,9 mm 3.81 in	96,9 mm 3.81 in	99,4 mm 3.91 in	99,4 mm 3.91 in
Section mini [C] Mini section	88,7 mm 3.49 in	88,7 mm 3.49 in	91,2 mm 3.59 in	91,2 mm 3.59 in
Diamètre de débouchage [D] Entrance bore diameter	21,5 mm 0.85 in	21,5 mm 0.85 in	21,5 mm 0.85 in	21,5 mm 0.85 in
Teinte Glass color	○ Extra Blanc Extra White Flint	○ Extra Blanc Extra White Flint	○ Extra Blanc Extra White Flint	○ Extra Blanc Extra White Flint

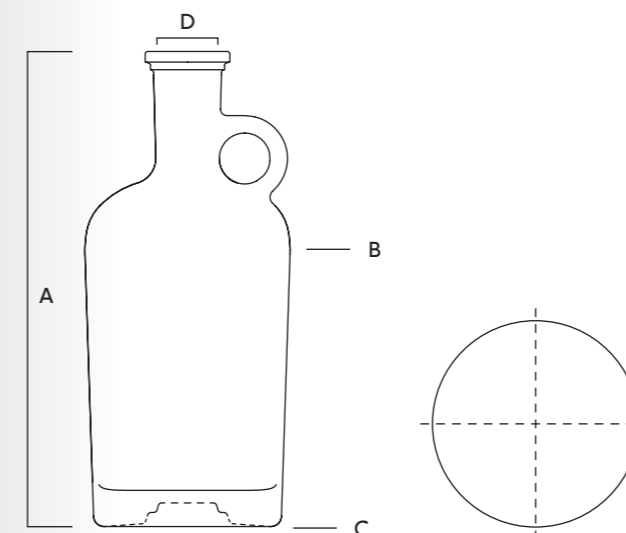

Modèle déposé « Design Saverglass »
Registered "Design Saverglass"

CEREMONY

SUPER PREMIUM

112 | 113



Atypique, presque inattendue de par sa forme concave, la bouteille CEREMONY impose un design distinctif viril aux proportions équilibrées. Le profil tout en courbes s'harmonise à la section rectangulaire arrondie et les larges faces planes offrent de d'innombrables possibilités de personnalisation. Ce modèle est disponible en version haute et basse.

Unique and almost surprising with its concave shape, the CEREMONY bottle exhibits a distinctly rugged design with balanced proportions. The curved profile blends in with the rounded rectangular cross-section and large flat panels that offer countless customization possibilities. This model is available in both tall and short versions.





CEREMONY
HAUTE



CEREMONY
BASSE



CEREMONY
BASSE

Contenance Capacity	70 cl 23.67 oz	70 cl 23.67 oz	75 cl 25.36 oz
Référence Reference	4824	4850	4851
Bague Finish	 Plate	 Plate	 Plate
Poids Weight	780 g 27.51 oz	780 g 27.51 oz	780 g 27.51 oz
Hauteur totale [A] Overall height	296,9 mm 11.69 in	230 mm 9.06 in	230 mm 9.06 in
Section maxi [B] Maxi section	96,4 × 60,1 mm 3.8 × 2.37 in	107,5 × 73,5 mm 4.23 × 2.89 in	110,3 × 76 mm 4.34 × 2.99 in
Section mini [C] Mini section	76,8 × 60,1 mm 3.02 × 2.37 in	89,5 × 73,5 mm 3.52 × 2.89 in	91,9 × 76 mm 3.62 × 2.99 in
Diamètre de débouchage [D] Entrance bore diameter	18,5 mm 0.73 in	21,5 mm 0.85 in	21,5 mm 0.85 in
Teinte Glass color	○ Extra Blanc Extra White Flint	○ Extra Blanc Extra White Flint	○ Extra Blanc Extra White Flint

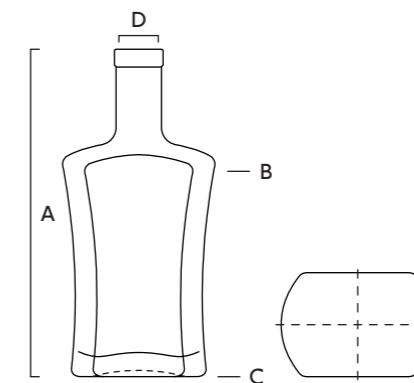
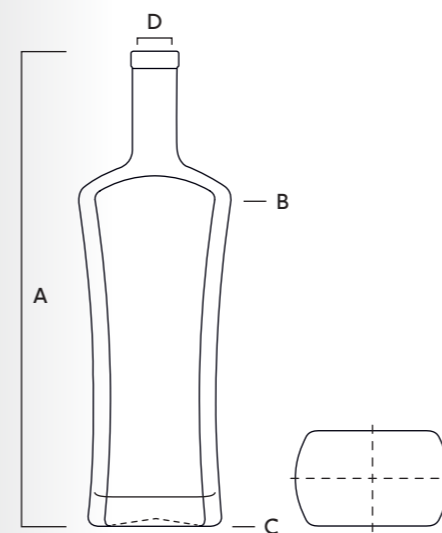

Modèle déposé « Design Saverglass »
Registered "Design Saverglass"

DIAMOND

SUPER PREMIUM





114 | 115



DIAMOND est une bouteille de forme carrée mi-haute adoucie par les lignes courbes de son épaulement. Elle tire son élégance de son fût conique, pensé pour une préhension parfaite. Cet équilibre des proportions et l'épaisseur de sa semelle sont les principaux atouts d'un flacon conçu pour se parer... A vous de jouer!

DIAMOND is a bottle of medium height featuring a square outline that is softened by the curved lines of its shoulder. It derives its elegance from its tapered body that is designed for the perfect grip. This balance of proportions and thickness of the base are the essential features of a bottle that is made to be embellished, and it's up to you how you want to do it.



Contenance Capacity	70 cl 23.67 oz	70 cl 23.67 oz	75 cl 25.36 oz	75 cl 25.36 oz
Référence Reference	5158	5158	5159	5159
Bague Finish	 Plate Bouchon à tête 29	 GPI 400/28	 Plate Bouchon à tête 29	 GPI 400/28
Poids Weight	821 g 28.96 oz	816 g 28.78 oz	835 g 29.45 oz	830 g 29.28 oz
Hauteur totale [A] Overall height	260 mm 10.24 in	259,2 mm 10.20 in	260 mm 10.24 in	259,2 mm 10.20 in
Section maxi [B] Maxi section	84,8 × 84,8 mm 3.34 × 3.34 in	84,8 × 84,8 mm 3.34 × 3.34 in	87 × 87 mm 3.43 × 3.43 in	87 × 87 mm 3.43 × 3.43 in
Section mini [C] Mini section	74,7 × 74,7 mm 2.94 × 2.94 in	74,7 × 74,7 mm 2.94 × 2.94 in	77 × 77 mm 3.03 × 3.03 in	77 × 77 mm 3.03 × 3.03 in
Diamètre de débouchage [D] Entrance bore diameter	18,5 mm 0.73 in	18,5 mm 0.73 in	18,5 mm 0.73 in	18,5 mm 0.73 in
Teinte Glass color	○ Extra Blanc Extra White Flint	○ Extra Blanc Extra White Flint	○ Extra Blanc Extra White Flint	○ Extra Blanc Extra White Flint

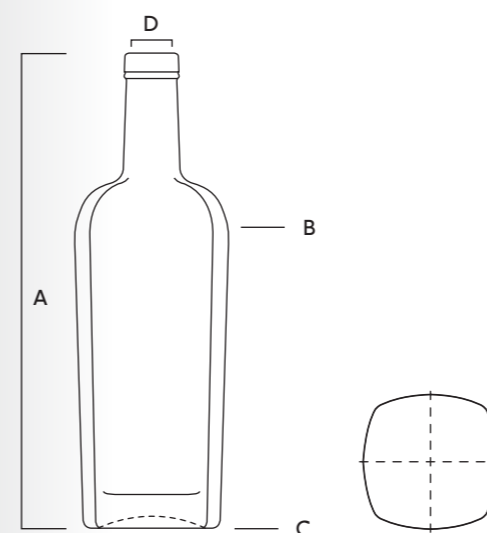

Modèle déposé « Design Saverglass »
Registered "Design Saverglass"

DYNAMITE

SUPER PREMIUM

116 | 117



Avec son allure de petit flacon discret que l'on imagine contenir de puissants élixirs, DYNAMITE créé la surprise. Rien n'est laissé au hasard pour cette bouteille de forme basse à la personnalité bien trempée. Sa section cylindrique offre ainsi un support idéal pour la personnalisation. DYNAMITE se distingue par ailleurs par son col court et droit surplombé d'une carnette vive, par son épaule au tracé plat puis oblique et par sa semelle de verre magnifiée par un pan coupé. Autant d'éléments forts et distinctifs qui participent à l'élaboration de ce cocktail explosif!

A small, discreet bottle in appearance and designed as a container for strong liqueurs, you're in for a surprise with DYNAMITE. Nothing is left to chance for this short bottle with a mature personality. Its round cross-section provides the perfect backdrop for customization. DYNAMITE also stands out with its glass base that is accentuated by a cutaway and a short and straight neck, crowned by a bold carnette finish and standing atop a shoulder that slants away from the neck before leveling out. All these strong and distinctive features add to the creation of this explosive cocktail!



Contenance
Capacity

70 cl
23.67 oz

75 cl
25.36 oz

Référence
Reference

5815

5862

Bague
Finish



Carnette



Carnette

Poids
Weight

782 g
27.58 oz

794 g
28.01 oz

Hauteur
totale [A]
Overall
height

209,8 mm
8.26 in

209,8 mm
8.26 in

Section
maxi [B]
Maxi
section

91,1 mm
3.59 in

93,6 mm
3.69 in

Diamètre de
débouchage
[D] Entrance
bore diameter

21,5 mm
0.85 in

21,5 mm
0.85 in

Teinte
Glass color

○ Extra Blanc
Extra White Flint

○ Extra Blanc
Extra White Flint

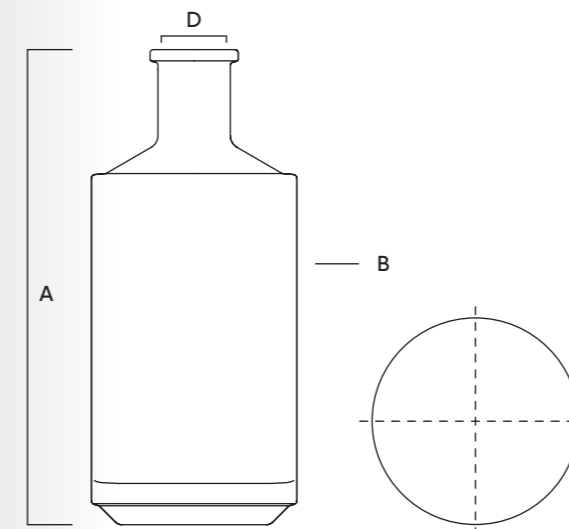

Modèle déposé « Design Saverglass »
Registered "Design Saverglass"

EMPIRE

SUPER PREMIUM

118 | 119



EMPIRE, modèle carré stylisé complexe, s'inspire de la splendeur des buildings Art déco de l'Amérique des années 1920. Son tracé contemporain respandit grâce aux multiples reflets de lumière créés par le jeu de ses facettes disposées savamment au niveau des arêtes. Son positionnement statutaire est renforcé par un épaulement horizontal et une épaisse semelle de verre. Ce modèle existe en version haute et basse.

EMPIRE is a multifaceted square bottle that takes inspiration from the splendor of American Art Deco buildings of the 1920s. Its modern outline sparkles thanks to the multiple reflections of light created by the interplay of its skillfully placed edges. Its statuesque positioning is accentuated by a level shoulder and thick glass base. This model is available in both tall and short versions.



EMPIRE HAUTE



EMPIRE HAUTE



EMPIRE BASSE



EMPIRE BASSE



EMPIRE BASSE

Contenance Capacity	70 cl 23.67 oz	75 cl 25.36 oz	70 cl 23.67 oz	70 cl 23.67 oz	75 cl 25.36 oz
Référence Reference	4813	4814	4811	4811	4812
Bague Finish	 Plate	 Plate	 Plate	 GPI 400/33	 Plate
Poids Weight	850 g 29.98 oz	850 g 29.98 oz	820 g 28.92 oz	820 g 28.92 oz	835 g 29.45 oz
Hauteur totale [A] Overall height	320 mm 12.60 in	320 mm 12.60 in	225 mm 8.86 in	226,2 mm 8.91 in	225 mm 8.86 in
Section maxi [B] Maxi section	75 × 75 mm 2.95 × 2.95 in	77,2 × 77,2 mm 3.04 × 3.04 in	85,5 × 85,5 mm 3.37 × 3.37 in	85,5 × 85,5 mm 3.37 × 3.37 in	88,8 × 88,8 mm 3.5 × 3.5 in
Section mini [C] Mini section	61,4 × 61,4 mm 2.42 × 2.42 in	62,9 × 62,9 mm 2.48 × 2.48 in	78,3 × 78,3 mm 3.08 × 3.08 in	78,3 × 78,3 mm 3.08 × 3.08 in	80,3 × 80,3 mm 3.16 × 3.16 in
Diamètre de débouchage [D] Entrance bore diameter	18,5 mm 0.73 in	18,5 mm 0.73 in	21,5 mm 0.85 in	21,5 mm 0.85 in	21,5 mm 0.85 in
Teinte Glass color	○ Extra Blanc Extra White Flint	○ Extra Blanc Extra White Flint	○ Extra Blanc Extra White Flint	○ Extra Blanc Extra White Flint	○ Extra Blanc Extra White Flint

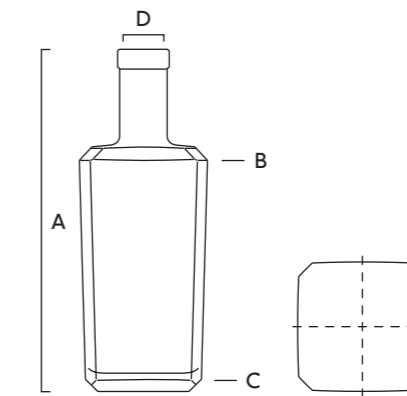
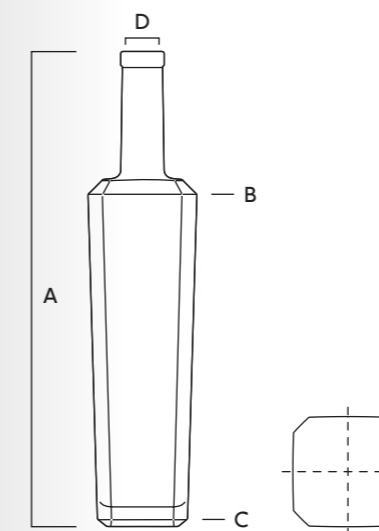

Modèle déposé « Design Saverglass »
Registered "Design Saverglass"

ESSENCIA

SUPER PREMIUM

120 | 121



ESSENCIA incarne à la fois l'élégance et une forme de simplicité dans une dimension sophistiquée. Sa silhouette allongée conique aux courbes voluptueuses se distingue par une épaule délicatement arrondie. Une épaisse semelle de verre a été ajoutée ainsi qu'un rétreint presque imperceptible au niveau du bas fût pour parfaire l'harmonie de l'ensemble.

ESSENCIA embodies both elegance and simplicity within sophisticated dimensions. Its elongated tapered silhouette with voluptuous curves is accentuated by a delicately rounded shoulder. A thick glass base has been added in addition to an extremely light tapering toward the bottom of the body to perfect the overall balance.



Contenance
Capacity

70 cl
23.67 oz

75 cl
25.36 oz

Référence
Reference

4872

4873

Bague
Finish



Poids
Weight

850 g
29.98 oz

850 g
29.98 oz

Hauteur
totale [A]
Overall
height

329 mm
12.95 in

329 mm
12.95 in

Section
maxi [B]
Maxi
section

82,2 mm
3.24 in

84,2 mm
3.31 in

Section
mini [C]
Mini
section

67,2 mm
2.65 in

69,2 mm
2.72 in

Diamètre de
débouchage
[D] Entrance
bore diameter

18,5 mm
0.73 in

18,5 mm
0.73 in

Teinte
Glass color

○ Extra Blanc
Extra White Flint

○ Extra Blanc
Extra White Flint

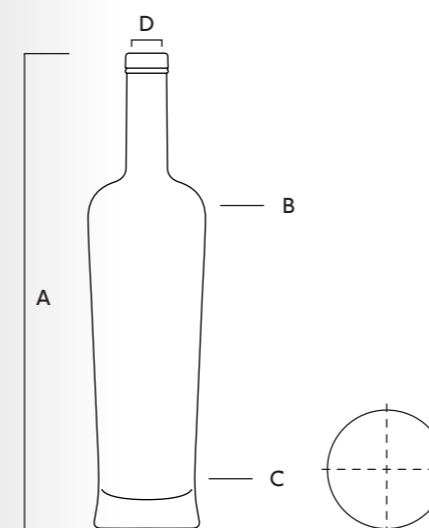

Modèle déposé « Design Saverglass »
Registered "Design Saverglass"

EXCEPTION

SUPER PREMIUM





122 | 123



À Cognac, le « paradis » est le lieu protégé où sont conservées les plus rares eaux-de vie. Le modèle EXCEPTION est dédié à ces mêmes alcools et réinterprète fidèlement les signes particuliers de l'ancienne bouteille charentaise : belle hauteur, fût conique et piqure de 50 mm caractérisent ce modèle ...d'exception. Aujourd'hui, la gamme s'est ouverte à de nombreuses autres applications, en restant, cependant, fidèle à des produits hors du commun.

In Cognac, "paradise" is the place where the rarest liqueurs are kept under lock and key. EXCEPTION is designed for these spirits and faithfully reproduces the unique characteristics of the old Charentaise bottle: beautiful height, tapered body, and 50 mm punt, all distinguishing features of this exceptional model. The range has now opened up to be used in a variety of new ways while still remaining dedicated to extraordinary products.



Contenance Capacity	50 cl 16.91 oz	70 cl 23.67 oz	75 cl 25.36 oz	100 cl 33.82 oz
Référence Reference	3328	1695	1939	6145
Bague Finish	 Plate déformée Bouchon à tête 29	 Plate déformée Bouchon à tête 29	 Plate déformée Bouchon à tête 29	 Plate déformée Bouchon à tête 29
Poids Weight	595 g 20.99 oz	760 g 26.81 oz	760 g 26.81 oz	962 g 33.93 oz
Hauteur totale [A] Overall height	286 mm 11.26 in	313 mm 12.32 in	313 mm 12.32 in	348,3 mm 13.71 in
Section maxi [B] Maxi section	72,4 mm 2.85 in	81,7 mm 3.22 in	83,5 mm 3.29 in	91,4 mm 3.6 in
Section mini [C] Mini section	67 mm 2.64 in	75,7 mm 2.98 in	77,5 mm 3.05 in	84,7 mm 3.33 in
Diamètre de débouchage [D] Entrance bore diameter	18,5 mm 0.73 in	18,5 mm 0.73 in	18,5 mm 0.73 in	18,5 mm 0.73 in
Teinte Glass color	○ Extra Blanc Extra White Flint	○ Extra Blanc Extra White Flint	○ Extra Blanc Extra White Flint	○ Extra Blanc Extra White Flint

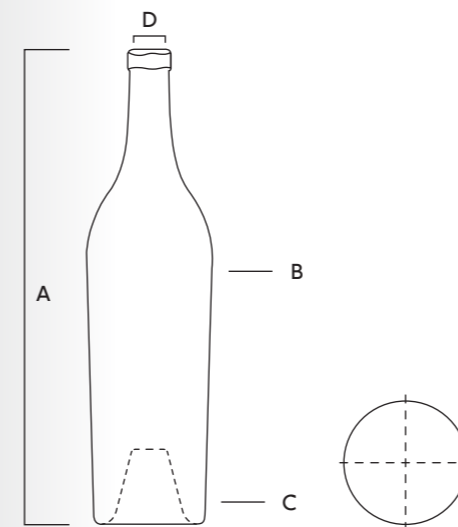

Modèle déposé « Design Saverglass »
Registered "Design Saverglass"

FIDJI

SUPER PREMIUM







FIDJI se distingue à la fois par sa haute stature gracile et sa section carrée. L'élégance générale du modèle, son trait vif, ont été travaillés grâce à l'apport d'un corps conique, d'une épaule au bel arrondi et d'une semelle de verre imposante permettant de souligner ainsi la pureté du flacon. Il est à noter également sa facilité de préhension et sa profondeur de gamme impressionnante (nombreuses contenances).

FIDJI stands out with its tall sleek stature and square cross-section. The model's overall elegance and bold character have been created with the addition of a tapered body, a beautifully rounded shoulder and a striking glass base, allowing the bottle's simplicity to be accentuated. Other notable features include its easy grip and impressively broad range (available in several sizes).





FIDJI

SUPER PREMIUM

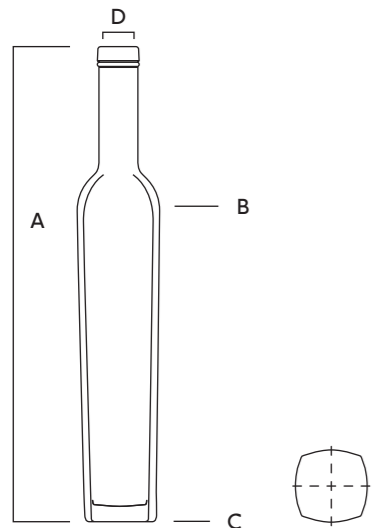

Contenance Capacity	5 cl 1.69 oz	35 cl 11.84 oz	37,5 cl 12.68 oz	50 cl 16.91 oz
Référence Reference	3492	2311	2497	2414
Bague Finish	 BVP 18 STD	 Plate Bouchon à tête 27	 Plate Bouchon à tête 27	 Plate Bouchon à tête 29
Poids Weight	98 g 3.46 oz	550 g 19.4 oz	550 g 19.4 oz	730 g 25.75 oz
Hauteur totale [A] Overall height	142 mm 5.59 in	319 mm 12.56 in	319 mm 12.56 in	343 mm 13.50 in
Section maxi [B] Maxi section	33,3 × 33,3 mm 1.31 × 1.31 in	56 × 56 mm 2.2 × 2.2 in	57,3 × 57,3 mm 2.26 × 2.26 in	64,3 × 64,3 mm 2.53 × 2.53 in
Section mini [C] Mini section	29,1 × 29,1 mm 1.15 × 1.15 in	47,6 × 47,6 mm 1.87 × 1.87 in	48,9 × 48,9 mm 1.93 × 1.93 in	54,3 × 54,3 mm 2.14 × 2.14 in
Diamètre de débouchage [D] Entrance bore diameter	10,5 mm 0.41 in	17,5 mm 0.69 in	17,5 mm 0.69 in	18,5 mm 0.73 in
Teinte Glass color	○ Extra Blanc Extra White Flint	○ Extra Blanc Extra White Flint	○ Extra Blanc Extra White Flint	○ Extra Blanc Extra White Flint



70 cl 23.67 oz	75 cl 25.36 oz	100 cl 33.82 oz	175 cl 59.18 oz	300 cl 101.45 oz
3255	3292	3549	3565	3816
 Plate Bouchon à tête 29	 Plate Bouchon à tête 29	 Plate Bouchon à tête 29	 Plate Bouchon à tête 34	 Plate Bouchon à tête 43
940 g 33.16 oz	940 g 33.16 oz	1190 g 41.98 oz	1650 g 58.2 oz	2800 g 98.77 oz
343 mm 13.50 in	343 mm 13.50 in	374,6 mm 14.75 in	441 mm 17.36 in	535,2 mm 21.07 in
75,2 × 75,2 mm 2.96 × 2.96 in	77 × 77 mm 3.03 × 3.03 in	84,4 × 84,4 mm 3.32 × 3.32 in	98,9 × 98,9 mm 3.89 × 3.89 in	118 × 118 mm 4.65 × 4.65 in
65,1 × 65,1 mm 2.56 × 2.56 in	66,9 × 66,9 mm 2.63 × 2.63 in	73,4 × 73,4 mm 2.89 × 2.89 in	85,9 × 85,9 mm 3.38 × 3.38 in	102,2 × 102,2 mm 4.02 × 4.02 in
18,5 mm 0.73 in	18,5 mm 0.73 in	18,5 mm 0.73 in	21,5 mm 0.85 in	23 mm 0.91 in
○ Extra Blanc Extra White Flint	○ Extra Blanc Extra White Flint	○ Extra Blanc Extra White Flint	○ Extra Blanc Extra White Flint	○ Extra Blanc Extra White Flint

FLAVOUR

SUPER PREMIUM





128 | 129



Archétype de la parabole, FLAVOUR affiche un style résolument moderne et interpelle le regard. Sa courbe plane symbolisée par un épaulement vif est symétrique par rapport à l'axe de son corps en forme de "U" aux lignes douces et arrondies. Tout concourt à l'attrait du modèle: des épaisseurs de verre judicieusement réparties, un bel équilibre des proportions, une élégance intemporelle...

Embodying the parabola shape, FLAVOUR flaunts its decidedly modern design and is a real eye-catcher. Its flat curve, exemplified in its bold shoulder, is symmetrical, mirroring along the centerline of its softly rounded U-shaped body. Taking the features as a whole adds to the model's attractiveness: skillfully distributed glass thicknesses, beautiful balance of proportions, and timeless elegance.



Contenance Capacity	70 cl 23.67 oz	70 cl 23.67 oz	75 cl 25.36 oz	75 cl 25.36 oz
Référence Reference	4834	4834	4835	4835
Bague Finish	 Plate	 GPI 400/33	 Plate	 GPI 400/33
Poids Weight	800 g 28.22 oz	810 g 28.57 oz	810 g 28.57 oz	820 g 28.92 oz
Hauteur totale [A] Overall height	220 mm 8.66 in	221,2 mm 8.71 in	220 mm 8.66 in	221,2 mm 8.71 in
Section maxi [B] Maxi section	99,7 mm 3.93 in	99,7 mm 3.93 in	102,2 mm 4.02 in	102,2 mm 4.02 in
Section mini [C] Mini section	78 mm 3.07 in	78 mm 3.07 in	80,5 mm 3.17 in	80,5 mm 3.17 in
Diamètre de débouchage [D] Entrance bore diameter	21,5 mm 0.85 in	21,5 mm 0.85 in	21,5 mm 0.85 in	21,5 mm 0.85 in
Teinte Glass color	○ Extra Blanc Extra White Flint	○ Extra Blanc Extra White Flint	○ Extra Blanc Extra White Flint	○ Extra Blanc Extra White Flint

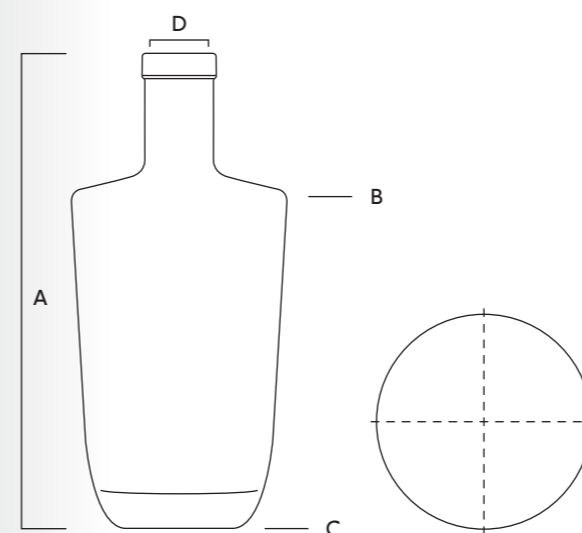

Modèle déposé « Design Saverglass »
Registered "Design Saverglass"

GEISHA

SUPER PREMIUM





130 | 131



GEISHA revendique ses origines! C'est en effet un design d'inspiration japonaise, entre fût de saké étiré et tige de bambou stylisée. Ses lignes fluides et élancées créent ici une bouteille à la fois délicate et singulière. GEISHA captive par cette subtile harmonie née de l'alliance de sa silhouette galbée à un épaulement vif et étroit.

GEISHA boldly asserts its origins, that is, of course, a Japanese-inspired design expressed by its elongated sake-style body and stylized bamboo stem. Its fluid and slender lines make it a delicate and unique bottle. This subtle harmony, created by marrying a curved silhouette and a bold narrow shoulder, makes GEISHA absolutely captivating.



Contenance Capacity	50 cl 16.91 oz	70 cl 23.67 oz	75 cl 25.36 oz	100 cl 33.82 oz
Référence Reference	4458	4124	4125	4329
Bague Finish	 Plate	 Plate	 Plate	 Plate
Poids Weight	560 g 19.75 oz	810 g 28.57 oz	823 g 29.03 oz	980 g 34.57 oz
Hauteur totale [A] Overall height	285,2 mm 11.23 in	320 mm 12.60 in	320 mm 12.60 in	346 mm 13.62 in
Section maxi [B] Maxi section	69,2 mm 2.72 in	77,4 mm 3.05 in	79,3 mm 3.12 in	87,4 mm 3.44 in
Section mini [C] Mini section	59,9 mm 2.36 in	67 mm 2.64 in	69 mm 2.72 in	76,1 mm 3 in
Diamètre de débouchage [D] Entrance bore diameter	18,5 mm 0.73 in	21,5 mm 0.85 in	21,5 mm 0.85 in	21,5 mm 0.85 in
Teinte Glass color	○ Extra Blanc Extra White Flint	○ Extra Blanc Extra White Flint	○ Extra Blanc Extra White Flint	○ Extra Blanc Extra White Flint

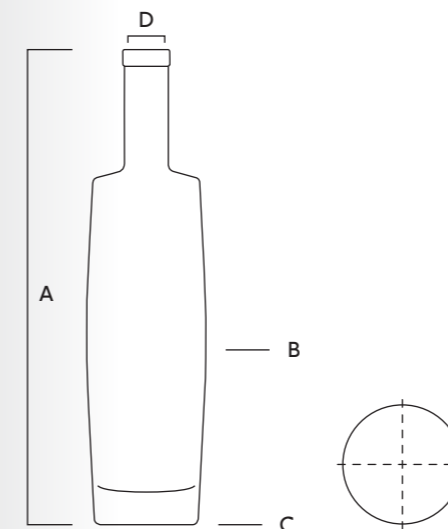





Modèle déposé « Design Saverglass »
Registered "Design Saverglass"



H2O? HDOZO! Son nom et sa forme révèlent l'esprit frondeur et le style décalé de ce flacon au col court, à l'épaulement rond et à la semelle épaisse directement inspirée des bouteilles d'eau minérale en PET. H DOZO représente cependant bien plus qu'un exercice de style, et joue sans retenue la carte du détournement d'emploi pour une interprétation haut de gamme.

H2O? H DOZO! The name and shape of this short-necked bottle showcase its rebellious spirit and offbeat style, featuring a round shoulder and thick base that take direct inspiration from plastic bottles of mineral water. However, H DOZO is much more than an exercise in design—it openly mimics this style to its advantage to create a premium look.



Contenance Capacity	70 cl 23.67 oz	70 cl 23.67 oz	75 cl 25.36 oz	75 cl 25.36 oz
Référence Reference	4423	4423	4424	4424
Bague Finish	 GPI 400/33	 MCA2	 GPI 400/33	 MCA2
Poids Weight	789 g 27.83 oz	793 g 27.97 oz	798 g 28.15 oz	801 g 28.25 oz
Hauteur totale [A] Overall height	294,2 mm 11.58 in	304,6 mm 11.99 in	294,2 mm 11.58 in	304,6 mm 11.99 in
Section maxi [B] Maxi section	74,6 mm 2.94 in	74,6 mm 2.94 in	76,7 mm 3.02 in	76,7 mm 3.02 in
Section mini [C] Mini section	72 mm 2.83 in	72 mm 2.83 in	74 mm 2.91 in	74 mm 2.91 in
Diamètre de débouchage [D] Entrance bore diameter	21,5 mm 0.85 in	17,5 mm 0.69 in	21,5 mm 0.85 in	17,5 mm 0.69 in
Teinte Glass color	○ Extra Blanc Extra White Flint	○ Extra Blanc Extra White Flint	○ Extra Blanc Extra White Flint	○ Extra Blanc Extra White Flint

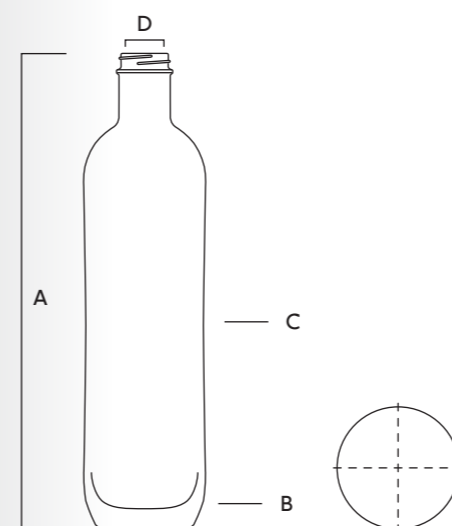





ISLAY se caractérise par une silhouette à la fois féminine et racée, une forme basse et conique, une épaisse semelle de verre et des formes généreuses qui participent pleinement à la versatilité du modèle. Cette bouteille super premium convient aux alcools bruns comme aux spiritueux blancs à la recherche d'une bouteille intemporelle et facilement personnalisable.

ISLAY is characterized by a feminine and elegant silhouette, short tapered profile, thick glass base and full-bodied contours, adding perfectly to the model's versatility. This super premium bottle is suitable for both dark and clear spirits that seek a timeless and easily customizable bottle.



Contenance Capacity	70 cl 23.67 oz	75 cl 25.36 oz
Référence Reference	4980	4981
Bague Finish	 Plate	 Plate
Poids Weight	810 g 28.57 oz	810 g 28.57 oz
Hauteur totale [A] Overall height	213 mm 8.39 in	213 mm 8.39 in
Section maxi [B] Maxi section	103,1 mm 4.06 in	105,5 mm 4.15 in
Section mini [C] Mini section	87,6 mm 3.45 in	90 mm 3.54 in
Diamètre de débouchage [D] Entrance bore diameter	21,5 mm 0.85 in	21,5 mm 0.85 in
Teinte Glass color	○ Extra Blanc Extra White Flint	○ Extra Blanc Extra White Flint

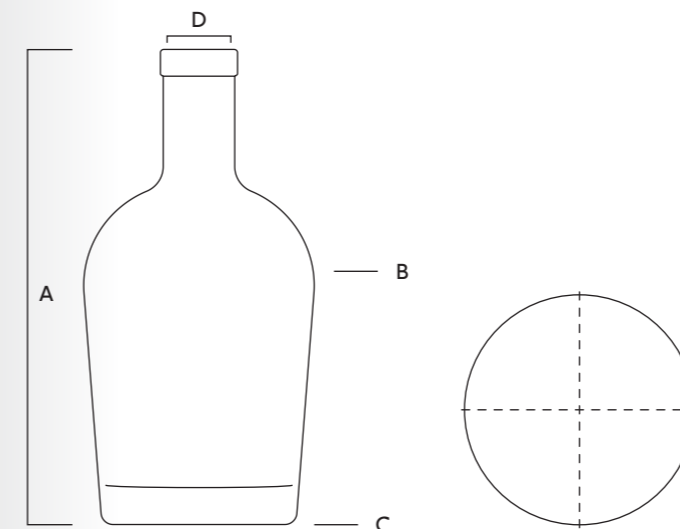

KENDO SPIRIT

SUPER PREMIUM













KENDO, forme iconique de Saverglass, fait référence à l'art martial japonais pratiqué avec un sabre de bambou. Au commencement, les contours de la canne servent à une interprétation où émerge une forme fluide, très pure, simple et intemporelle. Sa haute stature et un léger rétreint au niveau du corps façonnent la silhouette élégante de KENDO. Ce design limpide et ergonomique, parfaitement adapté à la personnalisation, est décliné suivant un large éventail de contenances.









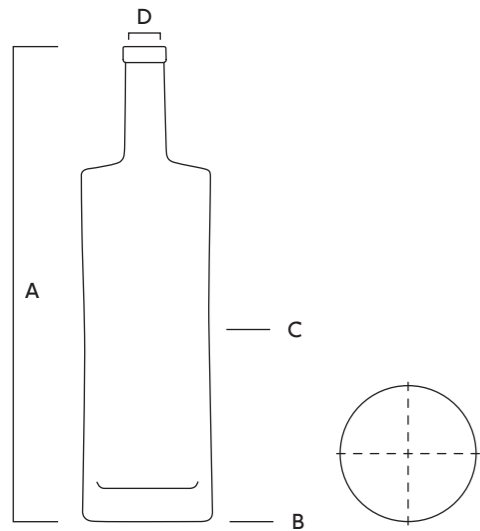

















KENDO, an iconic Saverglass shape, draws on the Japanese martial art that uses a bamboo sword. From the outset, the body's contours create a fluid, clean, simple and timeless profile. Its high stature and slight taper on the body shape the elegant KENDO silhouette. This crystalline and ergonomic design, perfectly suited to customization, is available in a wide range of capacities.

KENDO SPIRIT

SUPER PREMIUM

Contenance Capacity	5 cl 1.69 oz	35 cl 11.84 oz	35 cl 11.84 oz	37,5 cl 12.68 oz	37,5 cl 12.68 oz	50 cl 16.91 oz	50 cl 16.91 oz	70 cl 23.67 oz
Référence Reference	3391	3543	3543	3544	3544	3392	3392	3337
Bague Finish	 BVP 18 STD	 Plate	 GPI 400/28	 Plate	 GPI 400/28	 Plate	 GPI 400/28	 Plate
Poids Weight	98 g 3.46 oz	470 g 16.58 oz	485 g 17.11 oz	465 g 16.4 oz	485 g 17.11 oz	600 g 21.16 oz	619 g 21.83 oz	849 g 29.95 oz
Hauteur totale [A] Overall height	140,4 mm 5.53 in	255,2 mm 10.05 in	258,4 mm 10.17 in	255,2 mm 10.05 in	258,4 mm 10.17 in	287 mm 11.30 in	290,2 mm 11.43 in	320 mm 12.60 in
Section maxi [B] Maxi section	33,2 mm 1.31 in	60,5 mm 2.38 in	60,5 mm 2.38 in	62 mm 2.44 in	62 mm 2.44 in	67,5 mm 2.66 in	67,5 mm 2.66 in	75,9 mm 2.99 in
Section mini [C] Mini section	33,2 mm 1.31 in	58,9 mm 2.32 in	58,9 mm 2.32 in	60,4 mm 2.38 in	60,4 mm 2.38 in	65,5 mm 2.58 in	65,5 mm 2.58 in	72,9 mm 2.87 in
Diamètre de débouchage [D] Entrance bore diameter	10,5 mm 0.41 in	18,5 mm 0.73 in	18,5 mm 0.73 in	18,5 mm 0.73 in	18,5 mm 0.73 in	18,5 mm 0.73 in	18,5 mm 0.73 in	21,5 mm 0.85 in
Teinte Glass color	 Extra Blanc Extra White Flint	 Extra Blanc Extra White Flint	 Extra Blanc Extra White Flint	 Extra Blanc Extra White Flint	 Extra Blanc Extra White Flint	 Extra Blanc Extra White Flint	 Extra Blanc Extra White Flint	 Extra Blanc Extra White Flint



								
70 cl 23.67 oz	75 cl 25.36 oz	75 cl 25.36 oz	100 cl 33.82 oz	100 cl 33.82 oz	150 cl 50.72 oz	175 cl 59.18 oz	175 cl 59.18 oz	300 cl 101.45 oz
3337	3393	3393	3394	3394	3930	3545	3545	3763
 GPI 400/33	 Plate	 GPI 400/33	 Plate	 GPI 400/33	 Plate	 Plate	 GPI 400/33	 Plate
862 g 30.41 oz	857 g 30.23 oz	870 g 30.69 oz	1022 g 36.05 oz	1037 g 36.58 oz	1580 g 55.73 oz	1580 g 55.73 oz	1590 g 56.08 oz	2600 g 91.71 oz
321,2 mm 12.65 in	320 mm 12.60 in	321,2 mm 12.65 in	346 mm 13.62 in	347,2 mm 13.67 in	418 mm 16.46 in	418 mm 16.46 in	419,2 mm 16.50 in	522 mm 20.55 in
75,9 mm 2.99 in	78 mm 3.07 in	78 mm 3.07 in	85,6 mm 3.37 in	85,6 mm 3.37 in	96,4 mm 3.8 in	102 mm 4.02 in	102 mm 4.02 in	118,5 mm 4.67 in
72,9 mm 2.87 in	75 mm 2.95 in	75 mm 2.95 in	82,6 mm 3.25 in	82,6 mm 3.25 in	92,4 mm 3.64 in	98 mm 3.86 in	98 mm 3.86 in	113,8 mm 4.48 in
21,5 mm 0.85 in	21,5 mm 0.85 in	20,7 mm 0.81 in	21,5 mm 0.85 in	21,5 mm 0.85 in	21,5 mm 0.85 in	21,5 mm 0.85 in	21,5 mm 0.85 in	23 mm 0.91 in
 Extra Blanc Extra White Flint	 Extra Blanc Extra White Flint	 Extra Blanc Extra White Flint	 Extra Blanc Extra White Flint	 Extra Blanc Extra White Flint	 Extra Blanc Extra White Flint	 Extra Blanc Extra White Flint	 Extra Blanc Extra White Flint	 Extra Blanc Extra White Flint

KENDO SQUARE

SUPER PREMIUM

140 | 141



Forme cubique élancée, tout en élégance graphique, KENDO SQUARE puise son inspiration de la canne de bambou et marque les esprits par son architecture élaborée dans un style résolument futuriste. Design pur, ponctué de détails raffinés, la forme présente une section carrée, un épaulement plat tout en affirmant son caractère statuaire à l'aide d'un corps légèrement cintré, d'un socle de verre imposant et de colonnes de verre tirées aux arêtes vives. L'ensemble sublime admirablement les alcools qu'elle contient.

With a visually elegant, slender cubic shape, KENDO SQUARE draws its inspiration from the bamboo cane and accentuates the liqueurs contained within, featuring a structure that has been created in a decidedly futuristic style. With a clean design interspersed with fine details, the bottle's shape features a square cross-section and flat shoulder that asserts its statuesque character using a slightly curved body, striking glass base, and glass columns formed from bold edges. Taken together, the bottle's features beautifully enhance the spirits contained within.



Contenance
Capacity

70 cl
23.67 oz

75 cl
25.36 oz

Référence
Reference

4969

4970

Bague
Finish



Poids
Weight

812 g
28.64 oz

822 g
28.99 oz

Hauteur
totale [A]
Overall
height

323 mm
12.72 in

323 mm
12.72 in

Section
maxi [B]
Maxi
section

68,5 × 68,5 mm
2.7 × 2.7 in

70,8 × 70,8 mm
2.79 × 2.79 in

Section
mini [C]
Mini
section

65,5 × 65,5 mm
2.58 × 2.58 in

67,8 × 67,8 mm
2.67 × 2.67 in

Diamètre de
débouchage
[D] Entrance
bore diameter

21,5 mm
0.85 in

21,5 mm
0.85 in

Teinte
Glass color

○ Extra Blanc
Extra White Flint

○ Extra Blanc
Extra White Flint

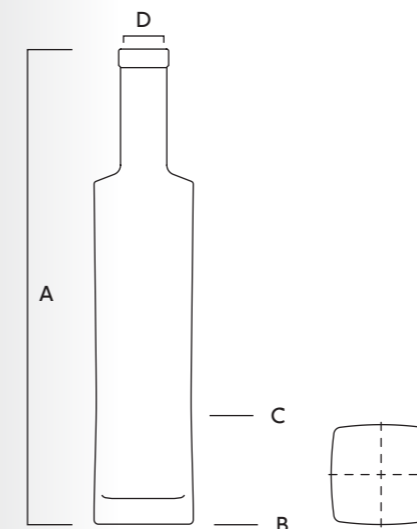

Modèle déposé « Design Saverglass »
Registered "Design Saverglass"

KIMONO

SUPER PREMIUM

142 | 143



Une forme pure, fluide et intrigante... Le modèle KIMONO suscite immédiatement toutes les convoitises: un corps ovalisé, légèrement cintré, avec un épaulement vif caractérise ce design élégant et sophistiqué. La surprise naît du profil du flacon avec la découverte de sa section ovale dotée d'un léger effet de torsion créant ainsi des arêtes vives et ondulantes en guise de plans de joint.

With a clean, fluid and intriguing profile, the KIMONO model immediately attracts longing looks. This elegant and sophisticated design is characterized by a bold shoulder and an oval body that is slightly pinched in at the sides. The bottle's profile reveals a surprise as it unveils its oval cross-section, featuring a slight pinching effect that brings out its bold undulating edges where the panels meet at the seams.



Contenance Capacity	5 cl 1.69 oz	70 cl 23.67 oz	75 cl 25.36 oz	100 cl 33.82 oz	175 cl 59.18 oz
Référence Reference	4618	4398	4399	4610	4608
Bague Finish	 BVP 18 STD	 Plate	 Plate	 Plate	 GPI 400/33
Poids Weight	99 g 3.49 oz	745 g 26.28 oz	760 g 26.81 oz	1010 g 35.63 oz	1458 g 51.43 oz
Hauteur totale [A] Overall height	135,5 mm 5.33 in	334,4 mm 13.17 in	334,4 mm 13.17 in	360 mm 14.17 in	417,6 mm 16.44 in
Section maxi [B] Maxi section	41 × 29,6 mm 1.61 × 1.17 in	89,4 × 64,4 mm 3.52 × 2.54 in	89,4 × 67,4 mm 3.52 × 2.65 in	100,8 × 76,2 mm 3.97 × 3 in	117,2 × 93,8 mm 4.61 × 3.69 in
Section mini [C] Mini section	37 × 27,8 mm 1.46 × 1.09 in	85,4 × 60,4 mm 3.36 × 2.38 in	85,4 × 63,4 mm 3.36 × 2.5 in	96,3 × 71,7 mm 3.79 × 2.82 in	111,9 × 88,5 mm 4.41 × 3.48 in
Diamètre de débouchage [D] Entrance bore diameter	10,5 mm 0.41 in	21,5 mm 0.85 in	21,5 mm 0.85 in	21,5 mm 0.85 in	21,5 mm 0.85 in
Teinte Glass color	○ Extra Blanc Extra White Flint	○ Extra Blanc Extra White Flint	○ Extra Blanc Extra White Flint	○ Extra Blanc Extra White Flint	○ Extra Blanc Extra White Flint

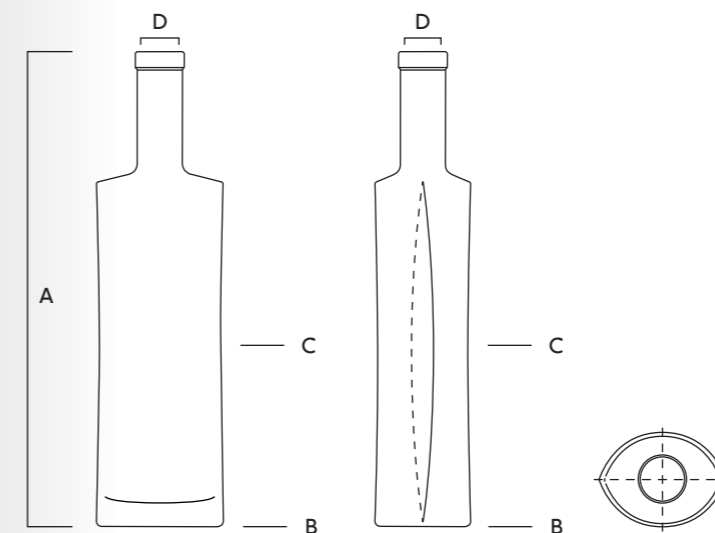

Modèle déposé « Design Saverglass »
Registered "Design Saverglass"

LITTLE PASHA

SUPER PREMIUM





144 | 145



Au premier regard, LITTLE PASHA apparaît comme un contenant solide et structuré, tout en équilibre. Des lignes fluides et souples nuancent cependant ce tempérament robuste: la vivacité de l'épaule est adoucie par un corps aux lignes courbes, insufflant avec grâce une touche espiègle à la silhouette. Une belle semelle de verre apporte enfin la note finale à ce flacon luxueux.

At first glance, LITTLE PASHA looks like a solid, structured and well-balanced container, yet its fluid and sleek lines slightly alter its robust nature: its bold shoulder is softened by a curvaceous body outline, elegantly imbuing the silhouette with a slight playfulness. A beautiful glass base adds the finishing touch to this luxurious bottle.



Contenance Capacity	70 cl 23.67 oz	75 cl 25.36 oz	100 cl 33.82 oz	300 cl 101.45 oz
Référence Reference	3923	3924	4190	5132
Bague Finish	 Plate	 Plate	 Plate	 Plate
Poids Weight	800 g 28.22 oz	800 g 28.22 oz	1000 g 35.27 oz	2511 g 88.57 oz
Hauteur totale [A] Overall height	208,7 mm 8.22 in	216,1 mm 8.51 in	249,6 mm 9.83 in	332,5 mm 13.09 in
Section maxi [B] Maxi section	101 mm 3.98 in	101 mm 3.98 in	108 mm 4.25 in	160 mm 6.3 in
Section mini [C] Mini section	72,4 mm 2.85 in	72,4 mm 2.85 in	76,2 mm 3 in	114,8 mm 4.52 in
Diamètre de débouchage [D] Entrance bore diameter	21,5 mm 0.85 in	21,5 mm 0.85 in	21,5 mm 0.85 in	23 mm 0.91 in
Teinte Glass color	○ Extra Blanc Extra White Flint	○ Extra Blanc Extra White Flint	○ Extra Blanc Extra White Flint	○ Extra Blanc Extra White Flint

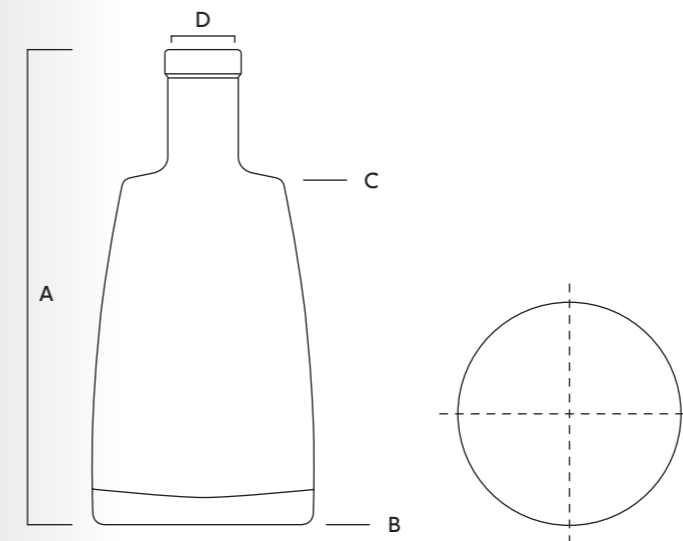

Modèle déposé « Design Saverglass »
Registered "Design Saverglass"

LITTLE SUMO

SUPER PREMIUM



Bouteille de forme basse versatile et ambivalente, ni tout à fait de section carrée, ni pour autant de forme ronde, c'est là que réside toute l'attractivité et la singularité du design de LITTLE SUMO. L'ergonomie de ses contours invite irrésistiblement à la prendre en main et à juger de cette masse de verre.

LITTLE SUMO is a short bottle that is made attractive and unique by its versatility and blend of styles – not quite a full square cross-section, but not too curvy either. Its ergonomic contours make picking up and beholding the glass impossible to resist.

LITTLE SUMO

SUPER PREMIUM



Contenance Capacity	35 cl 11.84 oz	35 cl 11.84 oz	37,5 cl 12.68 oz	50 cl 16.91 oz
Référence Reference	5152	5152	5153	5810
Bague Finish	 Plate	 GPI 400/28	 Plate	 Plate
Poids Weight	530 g 18.69 oz	532 g 18.77 oz	528 g 18.62 oz	643 g 22.68 oz
Hauteur totale [A] Overall height	169,5 mm 6.67 in	172,7 mm 6.80 in	169,5 mm 6.67 in	188 mm 7.40 in
Section maxi [B] Maxi section	77,2 × 83,3 mm 3.04 × 3.28 in	77,2 × 83,3 mm 3.04 × 3.28 in	78,9 × 84,9 mm 3.11 × 3.34 in	84,8 × 91,5 mm 3.34 × 3.6 in
Section mini [C] Mini section	72 × 77,8 mm 2.83 × 3.06 in	72 × 77,8 mm 2.83 × 3.06 in	73,7 × 79,5 mm 2.9 × 3.13 in	79,1 × 85,5 mm 3.11 × 3.37 in
Diamètre de débouchage [D] Entrance bore diameter	18,5 mm 0.73 in	18,5 mm 0.73 in	18,5 mm 0.73 in	21,5 mm 0.85 in
Teinte Glass color	○ Extra Blanc Extra White Flint	○ Extra Blanc Extra White Flint	○ Extra Blanc Extra White Flint	○ Extra Blanc Extra White Flint

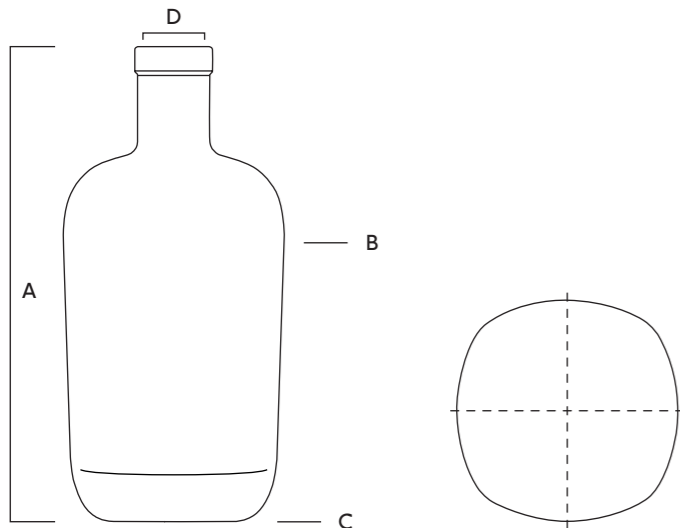

50 cl 16.91 oz	70 cl 23.67 oz	70 cl 23.67 oz	75 cl 25.36 oz	75 cl 25.36 oz	100 cl 33.82 oz
5810	4296	4296	4297	4297	5510
 GPI 400/33	 Plate	 GPI 400/33	 Plate	 GPI 400/33	 Plate
641 g 22.61 oz	900 g 31.75 oz	905 g 31.92 oz	920 g 32.45 oz	925 g 32.63 oz	1117 g 39.4 oz
189,2 mm 7.45 in	210,1 mm 8.27 in	211,3 mm 8.32 in	210,1 mm 8.27 in	211,3 mm 8.32 in	238,3 mm 9.38 in
84,8 × 91,5 mm 3.34 × 3.6 in	95,2 × 102,9 mm 3.75 × 4.05 in	95,2 × 102,9 mm 3.75 × 4.05 in	98 × 105,4 mm 3.86 × 4.15 in	98 × 105,4 mm 3.86 × 4.15 in	103,7 × 111,6 mm 4.08 × 4.39 in
79,1 × 85,5 mm 3.11 × 3.37 in	88,8 × 96,1 mm 3.5 × 3.78 in	88,8 × 96,1 mm 3.5 × 3.78 in	91,6 × 98,7 mm 3.61 × 3.89 in	91,6 × 98,7 mm 3.61 × 3.89 in	96,9 × 104,5 mm 3.81 × 4.11 in
20,7 mm 0.81 in	21,5 mm 0.85 in	20,7 mm 0.81 in	20,7 mm 0.81 in	21,5 mm 0.85 in	21,5 mm 0.85 in
○ Extra Blanc Extra White Flint	○ Extra Blanc Extra White Flint	○ Extra Blanc Extra White Flint	○ Extra Blanc Extra White Flint	○ Extra Blanc Extra White Flint	○ Extra Blanc Extra White Flint

LONG ISLAND

SUPER PREMIUM



Flacon mi-haut, parfaitement plat, LONG ISLAND conjugue équilibre, raffinement et versatilité. Ce conditionnement contemporain associe la rigueur d'une section rectangulaire à des faces planes puis est tempéré par le jeu d'alternance de ses contours souples tout en rondeur. LONG ISLAND dispose d'une large profondeur de gamme.

LONG ISLAND is a perfectly flat, mid-sized bottle that combines balance, sophistication and versatility. This contemporary container marries the strength of a rectangular cross-section with flat panels that are softened by the interplay of the bottle's smooth rounded edges. LONG ISLAND has an extensive range of capacities.

LONG ISLAND

SUPER PREMIUM



Contenance Capacity	5 cl 1.69 oz	35 cl 11.84 oz	35 cl 11.84 oz	37,5 cl 12.68 oz	37,5 cl 12.68 oz	50 cl 16.91 oz
Référence Reference	5134	5150	5150	5151	5151	5141
Bague Finish	 BVP 18 STD	 Plate	 GPI 400/28	 Plate	 GPI 400/28	 Plate
Poids Weight	105 g 3.7 oz	510 g 17.99 oz	511 g 18.02 oz	515 g 18.17 oz	516 g 18.2 oz	720 g 23.99 oz
Hauteur totale [A] Overall height	111,8 mm 4.40 in	207,9 mm 8.19 in	211,1 mm 8.31 in	207,9 mm 8.19 in	211,1 mm 8.31 in	227,3 mm 8.95 in
Section maxi [B] Maxi section	44,4 × 26 mm 1.75 × 1.02 in	82,3 × 43 mm 3.24 × 1.69 in	82,3 × 43 mm 3.24 × 1.69 in	82,3 × 45,3 mm 3.24 × 1.78 in	82,3 × 45,3 mm 3.24 × 1.78 in	90,4 × 50,5 mm 3.56 × 1.99 in
Diamètre de débouchage [D] Entrance bore diameter	10,5 mm 0.41 in	18,5 mm 0.73 in	18,5 mm 0.73 in	18,5 mm 0.73 in	18,5 mm 0.73 in	18,5 mm 0.73 in
Teinte Glass color	○ Extra Blanc Extra White Flint	○ Extra Blanc Extra White Flint	○ Extra Blanc Extra White Flint	○ Extra Blanc Extra White Flint	○ Extra Blanc Extra White Flint	○ Extra Blanc Extra White Flint



50 cl 16.91 oz	70 cl 23.67 oz	70 cl 23.67 oz	75 cl 25.36 oz	75 cl 25.36 oz	100 cl 33.82 oz	100 cl 33.82 oz
5141	4121	4121	4122	4122	4307	4307
 GPI 400/28	 Plate	 GPI 400/33	 Plate	 GPI 400/33	 Plate	 GPI 400/33
720 g 24.02 oz	890 g 31.39 oz	900 g 31.75 oz	890 g 31.39 oz	900 g 31.75 oz	1090 g 38.45 oz	1040 g 36.68 oz
230,5 mm 9.07 in	252,2 mm 9.93 in	253,4 mm 9.98 in	252,2 mm 9.93 in	253,4 mm 9.98 in	275,4 mm 10.84 in	276,9 mm 10.90 in
90,4 × 50,5 mm 3.56 × 1.99 in	99,9 × 56,2 mm 3.93 × 2.21 in	99,9 × 56,2 mm 3.93 × 2.21 in	99,9 × 59,2 mm 3.93 × 2.33 in	99,9 × 59,2 mm 3.93 × 2.33 in	109,7 × 64,5 mm 4.32 × 2.54 in	109,7 × 63,3 mm 4.32 × 2.49 in
18,5 mm 0.73 in	21,5 mm 0.85 in	21,5 mm 0.85 in	21,5 mm 0.85 in	21,5 mm 0.85 in	21,5 mm 0.85 in	21,5 mm 0.85 in
○ Extra Blanc Extra White Flint	○ Extra Blanc Extra White Flint	○ Extra Blanc Extra White Flint	○ Extra Blanc Extra White Flint	○ Extra Blanc Extra White Flint	○ Extra Blanc Extra White Flint	○ Extra Blanc Extra White Flint

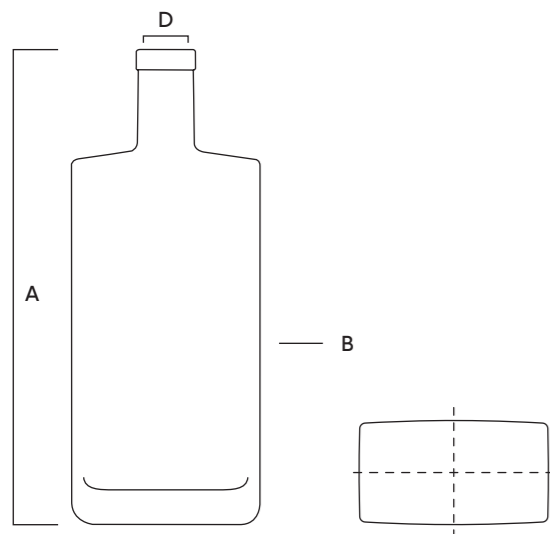



Sobriété, pureté et raffinement définissent un modèle inspiré par la délicatesse des codes de l'esthétique nipponne. MIYU est une forme mi-haute, aux lignes fluides, caractérisée par une silhouette galbée, un épaulement plat et vif, offrant ainsi l'accès à un flacon très modulable.

Simplicity, purity and sophistication are the defining features of this model, inspired by the delicacy of Japanese esthetic codes. MIYU is a mid-sized bottle that is shaped by smooth lines, characterized by a curvy silhouette and flat bold shoulder, and offers great versatility.



Contenance
Capacity

70 cl
23.67 oz

75 cl
25.36 oz

Référence
Reference

4972

4973

Bague
Finish



Plate



Plate

Poids
Weight

800 g
28.22 oz

810 g
28.57 oz

Hauteur
totale [A]
Overall
height

255 mm
10.04 in

255 mm
10.04 in

Section
maxi [B]
Maxi
section

79,9 mm
3.15 in

82,3 mm
3.24 in

Section
mini [C]
Mini
section

78,1 mm
3.07 in

80,4 mm
3.17 in

Diamètre de
débouchage
[D] Entrance
bore diameter

21,5 mm
0.85 in

21,5 mm
0.85 in

Teinte
Glass color

○ Extra Blanc
Extra White Flint

○ Extra Blanc
Extra White Flint

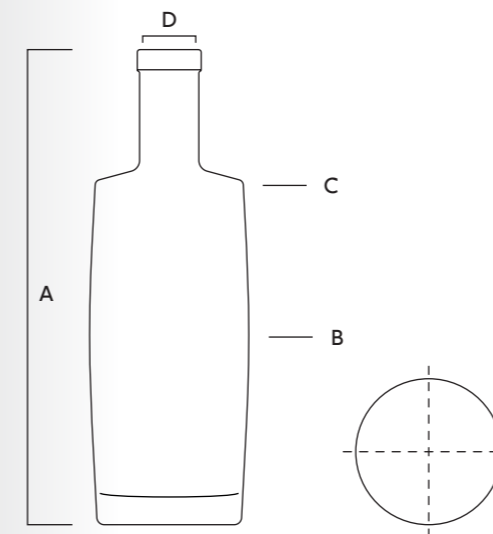

Modèle déposé « Design Saverglass »
Registered "Design Saverglass"

NEOS

SUPER PREMIUM



NEOS se singularise par sa forme ronde, une épaisse semelle de verre en guise de socle, un corps conique en forme de trapèze, un épaulement plat et vif et un col court. Ce joli flacon, marqué par une forme d'évidence, allie l'équilibre des proportions, une forme intemporelle, saupoudré d'un zest de singularité. Voici donc toutes les conditions réunies, pour que cette bouteille basse, s'adapte aisément à toutes les catégories de spiritueux. Le modèle dispose de nombreuses contenances.

NEOS stands out from the crowd with its curvy profile, trapezoidal tapered body, flat strong shoulder, short neck, and thick glass base that acts as a solid support. This attractive bottle, accentuated by its bold outline, combines balanced proportions and a timeless shape, sprinkled with a hint of individuality. The combination of all of these features make this short bottle easily adaptable to all types of spirits. The model is available in a range of capacities.

NEOS

SUPER PREMIUM



Contenance Capacity	5 cl 1.69 oz	20 cl 6.76 oz	20 cl 6.76 oz	35 cl 11.84 oz	35 cl 11.84 oz	37,5 cl 12.68 oz	37,5 cl 12.68 oz
------------------------	-----------------	------------------	------------------	-------------------	-------------------	---------------------	---------------------

Référence Reference	3752	4992	4992	3888	3888	3890	3890
------------------------	------	------	------	------	------	------	------

Bague Finish	BVP 18 STD	Plate	GPI 400/28	Plate	GPI 400/28	Plate	GPI 400/28
-----------------	------------	-------	------------	-------	------------	-------	------------

Poids Weight	94 g 3.32 oz	269 g 9.49 oz	280 g 9.88 oz	435 g 15.34 oz	440 g 15.52 oz	435 g 15.34 oz	440 g 15.52 oz
-----------------	-----------------	------------------	------------------	-------------------	-------------------	-------------------	-------------------

Hauteur totale [A] Overall height	98 mm 3.86 in	145 mm 5.71 in	149,8 mm 5.90 in	171,2 mm 6.74 in	174,4 mm 6.87 in	172,2 mm 6.78 in	175,4 mm 6.91 in
--	------------------	-------------------	---------------------	---------------------	---------------------	---------------------	---------------------

Section maxi [B] Maxi section	42,6 mm 1.68 in	65,3 mm 2.57 in	65,3 mm 2.57 in	78,1 mm 3.07 in	78,1 mm 3.07 in	80 mm 3.15 in	80 mm 3.15 in
--	--------------------	--------------------	--------------------	--------------------	--------------------	------------------	------------------

Section mini [C] Mini section	38,1 mm 1.5 in	48,6 mm 1.91 in	58,5 mm 2.3 in	70 mm 2.76 in	70 mm 2.76 in	71,9 mm 2.83 in	71,9 mm 2.83 in
--	-------------------	--------------------	-------------------	------------------	------------------	--------------------	--------------------

Diamètre de débouchage [D] Entrance bore diameter	10,5 mm 0.41 in	17,5 mm 0.69 in	18,5 mm 0.73 in	18,5 mm 0.73 in	18,5 mm 0.73 in	18,5 mm 0.73 in	18,5 mm 0.73 in
--	--------------------	--------------------	--------------------	--------------------	--------------------	--------------------	--------------------

Teinte Glass color	○ Extra Blanc Extra White Flint	○ Extra Blanc Extra White Flint	○ Extra Blanc Extra White Flint	○ Extra Blanc Extra White Flint	○ Extra Blanc Extra White Flint	○ Extra Blanc Extra White Flint	○ Extra Blanc Extra White Flint
-----------------------	------------------------------------	------------------------------------	------------------------------------	------------------------------------	------------------------------------	------------------------------------	------------------------------------

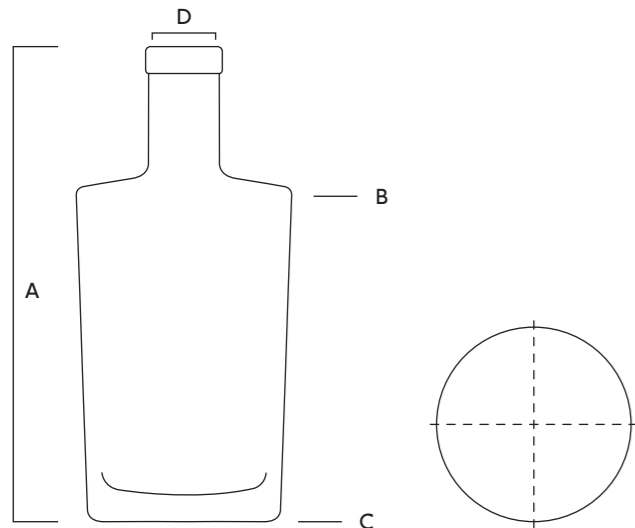

50 cl 16.91 oz	50 cl 16.91 oz	70 cl 23.67 oz	70 cl 23.67 oz	75 cl 25.36 oz	75 cl 25.36 oz	100 cl 33.82 oz	100 cl 33.82 oz
-------------------	-------------------	-------------------	-------------------	-------------------	-------------------	--------------------	--------------------

3697	3697	3557	3557	3563	3563	3614	3614
------	------	------	------	------	------	------	------

Plate	GPI 400/28	Plate	GPI 400/33	Plate	GPI 400/33	Plate	GPI 400/33
-------	------------	-------	------------	-------	------------	-------	------------

620 g 21.87 oz	625 g 22.05 oz	825 g 29.1 oz	830 g 29.28 oz	825 g 29.1 oz	830 g 29.28 oz	1055 g 37.21 oz	1060 g 37.39 oz
-------------------	-------------------	------------------	-------------------	------------------	-------------------	--------------------	--------------------

191 mm 7.52 in	194,2 mm 7.65 in	213,5 mm 8.41 in	214,7 mm 8.45 in	221 mm 8.70 in	222,2 mm 8.75 in	258,8 mm 10.19 in	260 mm 10.24 in
-------------------	---------------------	---------------------	---------------------	-------------------	---------------------	----------------------	--------------------

88,1 mm 3.47 in	88,1 mm 3.47 in	97,2 mm 3.83 in	97,2 mm 3.83 in	97,2 mm 3.83 in	97,2 mm 3.83 in	102 mm 4.02 in	102 mm 4.02 in
--------------------	--------------------	--------------------	--------------------	--------------------	--------------------	-------------------	-------------------

79,1 mm 3.11 in	79,1 mm 3.11 in	87,2 mm 3.43 in	87,2 mm 3.43 in	87,2 mm 3.43 in	87,2 mm 3.43 in	94 mm 3.7 in	94 mm 3.7 in
--------------------	--------------------	--------------------	--------------------	--------------------	--------------------	-----------------	-----------------

18,5 mm 0.73 in	18,5 mm 0.73 in	21,5 mm 0.85 in	21,5 mm 0.85 in	21,5 mm 0.85 in	21,5 mm 0.85 in	21,5 mm 0.85 in	21,5 mm 0.85 in
--------------------	--------------------	--------------------	--------------------	--------------------	--------------------	--------------------	--------------------





○ Extra Blanc Extra White Flint	○ Extra Blanc Extra White Flint	○ Extra Blanc Extra White Flint	○ Extra Blanc Extra White Flint	○ Extra Blanc Extra White Flint	○ Extra Blanc Extra White Flint	○ Extra Blanc Extra White Flint	○ Extra Blanc Extra White Flint
------------------------------------	------------------------------------	------------------------------------	------------------------------------	------------------------------------	------------------------------------	------------------------------------	------------------------------------



Épaisse semelle de verre, forme conique mi-haute surmontée d'un épaulement plat et vif et d'un col court sont les principales caractéristiques de cette silhouette intemporelle. NESS conquiert également les utilisateurs par sa grande fonctionnalité et l'équilibre général de ses proportions qui conviendront donc facilement à tous types de spiritueux.

This timeless silhouette features a thick glass base and a mid-sized tapered body, topped with a flat bold shoulder and short neck. NESS also wins the hearts of its users with its great functionality and overall balance of proportions, making it easily adaptable to all types of spirits.



Contenance Capacity	70 cl 23.67 oz	70 cl 23.67 oz	75 cl 25.36 oz	75 cl 25.36 oz
Référence Reference	4815	4815	4816	4816
Bague Finish	 Plate	 GPI 400/33	 Plate	 GPI 400/33
Poids Weight	785 g 27.69 oz	770 g 27.16 oz	789 g 27.83 oz	780 g 27.51 oz
Hauteur totale [A] Overall height	250 mm 9.84 in	251,2 mm 9.89 in	250 mm 9.84 in	251,2 mm 9.89 in
Section maxi [B] Maxi section	89,2 mm 3.51 in	89,2 mm 3.51 in	91,7 mm 3.61 in	91,7 mm 3.61 in
Section mini [C] Mini section	78,2 mm 3.08 in	78,2 mm 3.08 in	80,4 mm 3.17 in	80,4 mm 3.17 in
Diamètre de débouchage [D] Entrance bore diameter	21,5 mm 0.85 in	21,5 mm 0.85 in	21,5 mm 0.85 in	21,5 mm 0.85 in
Teinte Glass color	○ Extra Blanc Extra White Flint	○ Extra Blanc Extra White Flint	○ Extra Blanc Extra White Flint	○ Extra Blanc Extra White Flint

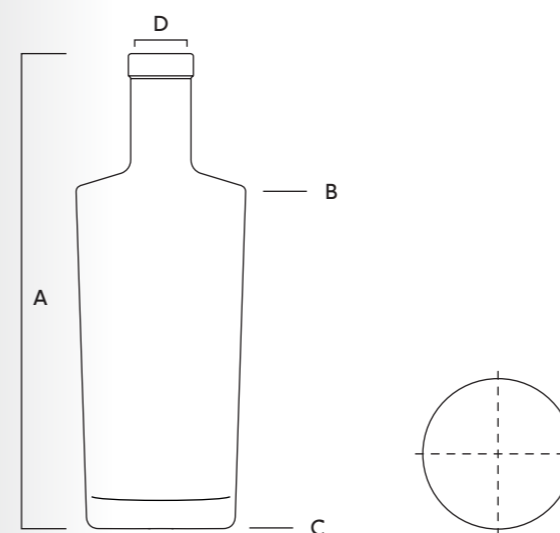

NUMBER ONE

SUPER PREMIUM

162 | 163



NUMBER ONE affiche des ambitions de leader! Une section ovale contrariée par des épaules carrées parfaitement horizontales, font apparaître deux faces quasi-planes et évasées posées sur une épaisse semelle de verre. Tout concourt dans cette réalisation à marquer sa différence. On comprendra alors que son caractère transgressif, avant-gardiste et décalé soit approprié à l'univers des Spiritueux Premium. Cette bouteille singulière se décline en version haute ou basse.

NUMBER ONE boasts leadership ambitions. This bottle features an oval cross-section contrasted with perfectly level square shoulders, giving way to two slightly sloping tapered panels on top of a thick glass base. Taken together, its features make the bottle stand out. You will see how its rule-breaking, avant-garde and offbeat character makes it suitable for a whole range of premium spirits. This unique bottle is available in either a tall or short version.



NUMBER ONE
HAUTE







NUMBER ONE
HAUTE



NUMBER ONE
BASSE



NUMBER ONE
BASSE

Contenance Capacity	70 cl 23.67 oz	75 cl 25.36 oz	70 cl 23.67 oz	75 cl 25.36 oz
Référence Reference	4867	4868	4874	4875
Bague Finish	 Plate	 Plate	 Plate	 Plate
Poids Weight	860 g 30.34 oz	866 g 30.55 oz	960 g 33.86 oz	970 g 34.22 oz
Hauteur totale [A] Overall height	329 mm 12.95 in	329 mm 12.95 in	236,8 mm 9.32 in	236,8 mm 9.32 in
Section maxi [B] Maxi section	89,1 × 61,2 mm 3.51 × 2.41 in	91,6 × 63 mm 3.61 × 2.48 in	110,3 × 76,3 mm 4.34 × 3 in	112,6 × 78,6 mm 4.43 × 3.09 in
Section mini [C] Mini section	58,7 × 58,7 mm 2.31 × 2.31 in	60,4 × 60,4 mm 2.38 × 2.38 in	74,2 × 74,2 mm 2.92 × 2.92 in	76,5 × 76,5 mm 3.01 × 3.01 in
Diamètre de débouchage [D] Entrance bore diameter	18,5 mm 0.73 in	18,5 mm 0.73 in	21,5 mm 0.85 in	21,5 mm 0.85 in
Teinte Glass color	○ Extra Blanc Extra White Flint	○ Extra Blanc Extra White Flint	○ Extra Blanc Extra White Flint	○ Extra Blanc Extra White Flint

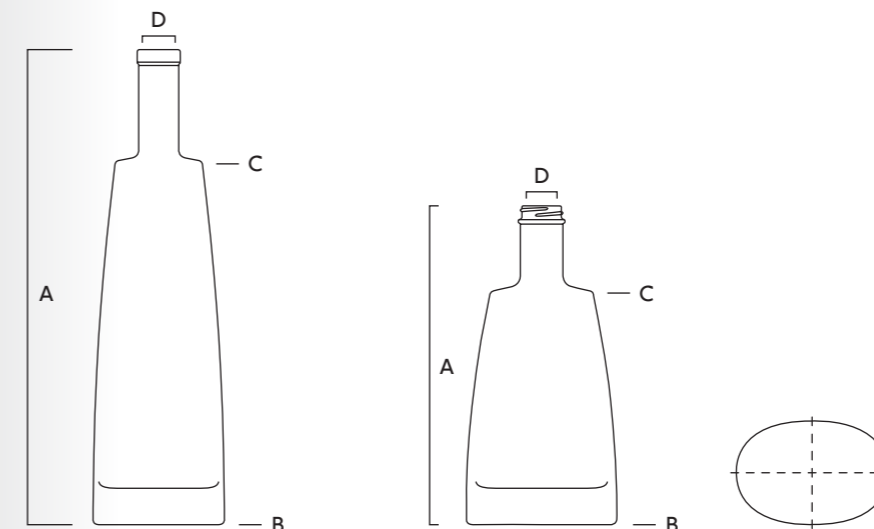

Modèle déposé « Design Saverglass »
Registered "Design Saverglass"

OSLO

SUPER PREMIUM



La "beauté naturelle" d'OSLO repose sur deux grands principes: sobriété des lignes et élégance des proportions. Si sa silhouette rappelle les flacons d'officines des pharmaciens d'autrefois, elle réinterprète la partition avec modernité et limpidité: section ronde, demi-ellipse, forme compacte, OSLO est assurément l'un des contenants les plus versatiles possibles et s'adapte à toutes formes de personnalisation. Cette gamme est déclinée sous de nombreuses contenances.

The "natural beauty" of OSLO rests on two main principles: clean lines and elegant proportions. While its silhouette is reminiscent of old dispensary medicine bottles, its composition has been reinterpreted with modernity and simplicity: with a round cross-section and a partially elliptical and compact profile, OSLO is undoubtedly one of the most versatile containers available and can be adapted to any kind of customization. This range is available in several capacities.









OSLO

SUPER PREMIUM



Contenance Capacity	5 cl 1.69 oz	20 cl 6.76 oz	20 cl 6.76 oz	35 cl 11.84 oz	35 cl 11.84 oz	37,5 cl 12.68 oz	37,5 cl 12.68 oz	50 cl 16.91 oz	50 cl 16.91 oz
------------------------	-----------------	------------------	------------------	-------------------	-------------------	---------------------	---------------------	-------------------	-------------------

Référence Reference	2843	3019	3019	3168	3168	3169	3169	2844	2844
------------------------	------	------	------	------	------	------	------	------	------







Bague Finish	 BVP 18 STD	 Plate SB 26	 GPI 400/28	 Plate	 GPI 400/28	 Plate	 GPI 400/28	 Plate	 GPI 400/28
-----------------	---	--	---	--	---	--	---	--	---

Poids Weight	95 g 3.35 oz	280 g 9.88 oz	282 g 9.95 oz	420 g 14.81 oz	429 g 15.13 oz	420 g 14.81 oz	429 g 15.13 oz	580 g 20.46 oz	588 g 20.74 oz
-----------------	-----------------	------------------	------------------	-------------------	-------------------	-------------------	-------------------	-------------------	-------------------

Hauteur totale [A] Overall height	98,5 mm 3.88 in	144,6 mm 5.69 in	149,4 mm 5.88 in	174,2 mm 6.86 in	177,4 mm 6.98 in	174,2 mm 6.86 in	177,4 mm 6.98 in	191 mm 7.52 in	194,2 mm 7.65 in
--	--------------------	---------------------	---------------------	---------------------	---------------------	---------------------	---------------------	-------------------	---------------------

Section maxi [B] Maxi section	41,4 mm 1.63 in	63,2 mm 2.49 in	63,2 mm 2.49 in	74,8 mm 2.94 in	74,8 mm 2.94 in	76,7 mm 3.02 in	76,7 mm 3.02 in	84,3 mm 3.32 in	84,3 mm 3.32 in
--	--------------------	--------------------	--------------------	--------------------	--------------------	--------------------	--------------------	--------------------	--------------------

Diamètre de débouchage [D] Entrance bore diameter	10,5 mm 0.41 in	17,5 mm 0.69 in	18,5 mm 0.73 in	18,5 mm 0.73 in	18,5 mm 0.73 in	18,5 mm 0.73 in	18,5 mm 0.73 in	18,5 mm 0.73 in	18,5 mm 0.73 in
--	--------------------	--------------------	--------------------	--------------------	--------------------	--------------------	--------------------	--------------------	--------------------

Teinte Glass color	 Extra Blanc Extra White Flint	 Extra Blanc Extra White Flint	 Extra Blanc Extra White Flint	 Extra Blanc Extra White Flint	 Extra Blanc Extra White Flint	 Extra Blanc Extra White Flint	 Extra Blanc Extra White Flint	 Extra Blanc Extra White Flint	 Extra Blanc Extra White Flint
-----------------------	--	--	--	--	--	--	--	--	--

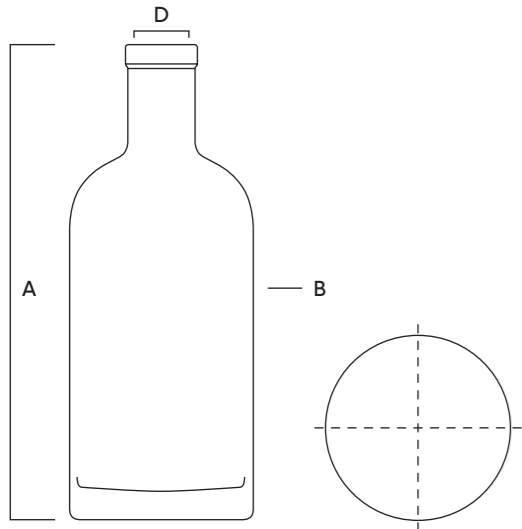

70 cl 23.67 oz	70 cl 23.67 oz	75 cl 25.36 oz	75 cl 25.36 oz	100 cl 33.82 oz	100 cl 33.82 oz	150 cl 50.72 oz	150 cl 50.72 oz	175 cl 59.18 oz	175 cl 59.18 oz	450 cl 152.18 oz
-------------------	-------------------	-------------------	-------------------	--------------------	--------------------	--------------------	--------------------	--------------------	--------------------	---------------------

2845	2845	2846	2846	2847	2847	3637	3637	3196	3196	3730
------	------	------	------	------	------	------	------	------	------	------

 Plate	 GPI 400/33	 Plate	 GPI 400/33	 Plate	 GPI 400/33	 Plate	 GPI 400/33	 Plate	 GPI 400/33	 Plate
--	---	--	---	--	---	--	---	--	---	--

786 g 27.72 oz	796 g 28.08 oz	785 g 27.69 oz	794 g 28.01 oz	1027 g 36.23 oz	1036 g 36.54 oz	1420 g 50.09 oz	1415 g 49.91 oz	1600 g 56.44 oz	1595 g 56.26 oz	3400 g 119.93 oz
-------------------	-------------------	-------------------	-------------------	--------------------	--------------------	--------------------	--------------------	--------------------	--------------------	---------------------

213 mm 8.39 in	214,2 mm 8.43 in	220,2 mm 8.67 in	221,4 mm 8.72 in	277,5 mm 10.93 in	278,7 mm 10.97 in	305,4 mm 12.02 in	306,6 mm 12.07 in	320,2 mm 12.61 in	321,4 mm 12.65 in	389,5 mm 15.33 in
-------------------	---------------------	---------------------	---------------------	----------------------	----------------------	----------------------	----------------------	----------------------	----------------------	----------------------

94 mm 3.7 in	94 mm 3.7 in	94 mm 3.7 in	94 mm 3.7 in	95 mm 3.74 in	95 mm 3.74 in	112 mm 4.41 in	112 mm 4.41 in	117,7 mm 4.63 in	117,7 mm 4.63 in	166,4 mm 6.55 in
-----------------	-----------------	-----------------	-----------------	------------------	------------------	-------------------	-------------------	---------------------	---------------------	---------------------

21,5 mm 0.85 in	20,7 mm 0.81 in	21,5 mm 0.85 in	20,7 mm 0.81 in	21,5 mm 0.85 in	21,5 mm 0.85 in	21,5 mm 0.85 in	21,5 mm 0.85 in	21,5 mm 0.85 in	21,5 mm 0.85 in	28 mm 1.1 in
--------------------	--------------------	--------------------	--------------------	--------------------	--------------------	--------------------	--------------------	--------------------	--------------------	-----------------

 Extra Blanc Extra White Flint	 Extra Blanc Extra White Flint	 Extra Blanc Extra White Flint	 Extra Blanc Extra White Flint	 Extra Blanc Extra White Flint	 Extra Blanc Extra White Flint	 Extra Blanc Extra White Flint	 Extra Blanc Extra White Flint	 Extra Blanc Extra White Flint	 Extra Blanc Extra White Flint	 Extra Blanc Extra White Flint
--	--	--	--	--	--	--	--	--	--	--

OSLO APOTHEK

SUPER PREMIUM



Classique, statuaire et intemporel, en filiation directe du modèle OSLO, OSLO APOTHEK réinterprète, avec élégance et raffinement, les flacons d'apothicaires d'antan. Son corps élancé, sublimé par une épaisse semelle de verre et son col haut surmonté d'une bague carnette font écho à l'une des tendances phares sur le marché des spiritueux haut de gamme.

Classical, statuesque and timeless, a direct descendant of the OSLO model, OSLO APOTHEK reinterprets the apothecary medicine bottles of yesteryear with elegance and sophistication. Its slender body is accentuated by a thick glass base and features a tall neck crowned with a carnette finish, making it consistent with one of the leading trends in the premium spirits market.

OSLO APOTHEK

SUPER PREMIUM



Contenance Capacity	20 cl 6.76 oz	50 cl 16.91 oz	50 cl 16.91 oz
Référence Reference	6394	6061	6061
Bague Finish	 Carnette	 Carnette	 Pate
Poids Weight	279 g 9.84 oz	567 g 20.00 oz	562 g 19.82 oz
Hauteur totale [A] Overall height	163,1 mm 6.42 in	214,7 mm 8.45 in	220,1 mm 8.67 in
Section maxi [B] Maxi section	57 mm 2.24 in	75,5 mm 2.97 in	75,5 mm 2.97 in
Diamètre de débouchage [D] Entrance bore diameter	15,5 mm 0.61 in	21,5 mm 0.85 in	21,5 mm 0.85 in
Teinte Glass color	○ Extra Blanc Extra White Flint	○ Extra Blanc Extra White Flint	○ Extra Blanc Extra White Flint

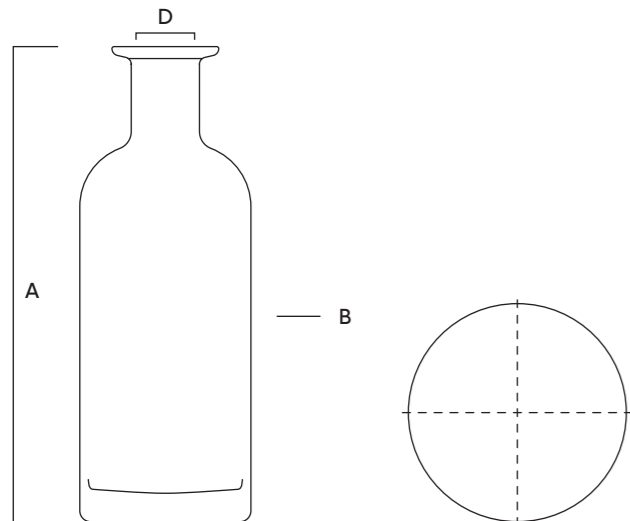

70 cl 23.67 oz	70 cl 23.67 oz	75 cl 25.36 oz	75 cl 25.36 oz
5563	5563	5595	5595
 Carnette	 Plate	 Carnette	 Plate
800 g 28.22 oz	805 g 28.4 oz	800 g 28.22 oz	802 g 28.29 oz
240,1 mm 9.45 in	246,3 mm 9.70 in	240,1 mm 9.45 in	246,3 mm 9.70 in
84,4 mm 3.32 in	84,4 mm 3.32 in	86,5 mm 3.41 in	86,5 mm 3.41 in
23 mm 0.91 in	23 mm 0.91 in	23 mm 0.91 in	23 mm 0.91 in
○ Extra Blanc Extra White Flint	○ Extra Blanc Extra White Flint	○ Extra Blanc Extra White Flint	○ Extra Blanc Extra White Flint

PEARL

SUPER PREMIUM

172 | 173



Bénéficiant d'un design étonnant à mi-chemin entre la bouteille et la carafe, PEARL s'appuie sur une section ronde, élevée en forme pyramidale haute. PEARL se joue des apparences et cultive sa singularité grâce notamment à sa bague carnette, la courbe de son bas fût et son épaisse semelle de verre dans laquelle s'insère un bombage plat. Ces détails haut de gamme favorisent les reflets et nuances tout en contribuant à la mise en valeur des alcools les plus précieux.

With a striking design halfway between bottle and decanter, PEARL comprises a round cross-section, raised in a tall pyramid shape. PEARL defies appearances and develops its own unique character thanks to its carnette finish, curved lower body, and thick glass base that incorporates a thin dome. These premium details promote luminosity and subtlety while helping to enhance the finest spirits.



Contenance
Capacity

70 cl
23.67 oz

75 cl
25.36 oz

Référence
Reference

5823

5865

Bague
Finish

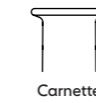

Carnette

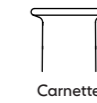

Carnette

Poids
Weight

896 g
31.6 oz

900 g
31.75 oz

Hauteur
totale [A]
Overall
height

259 mm
10.20 in

259 mm
10.20 in

Section
maxi [B]
Maxi
section

117,2 mm
4.61 in

120,7 mm
4.75 in

Diamètre de
débouchage
[D] Entrance
bore diameter

23 mm
0.91 in

23 mm
0.91 in

Teinte
Glass color

○ Extra Blanc
Extra White Flint

○ Extra Blanc
Extra White Flint

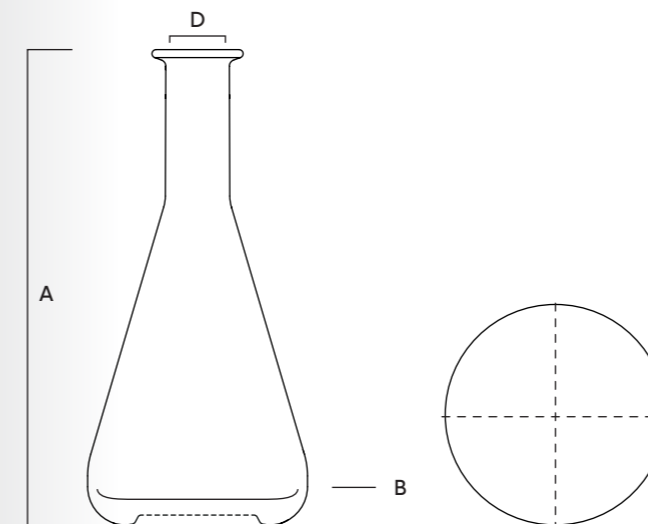

PIRATE

SUPER PREMIUM

174 | 175



Évoquant l'âge d'or de la piraterie dans les Caraïbes à la fin du XVII^e siècle, cette bouteille au design spectaculaire surprend et attire par la quantité de détails qu'elle comporte: sa forme de trapèze arrondi et son diamètre imposant, sa conicité et sa haute stature constituée d'un col long évasé pour une préhension plus aisée, sa bague carnette coiffant le tout ou son bombage vif, circulaire et extra-plat viennent parachever une épaisse semelle de verre destinée à révéler les reflets plus subtils des élixirs d'exception.

Evoking the golden age of piracy in the Caribbean in the late 17th century, the sheer amount of detail in this spectacularly designed bottle makes it eye-catching and gives it the wow factor: rounded trapezoid shape with an impressive diameter; conical body and high stature, including a long flared neck for more comfortable handling; crowned by a carnette finish; and featuring a bold, round and extra-thin dome that puts the finishing touch on a thick glass base that is designed to showcase the more subtle luminosity of exceptional spirits.



Contenance
Capacity

70 cl
23.67 oz

75 cl
25.36 oz

Référence
Reference

5809

5863

Bague
Finish



Carnette



Carnette

Poids
Weight

950 g
33.51 oz

955 g
33.69 oz

Hauteur
totale [A]
Overall
height

239 mm
9.41 in

239 mm
9.41 in

Section
maxi [B]
Maxi
section

114,3 mm
4.5 in

117,2 mm
4.61 in

Section
mini [C]
Mini
section

98,8 mm
3.89 in

101,8 mm
4.01 in

Diamètre de
débouchage
[D] Entrance
bore diameter

21,5 mm
0.85 in

21,5 mm
0.85 in

Teinte
Glass color

○ Extra Blanc
Extra White Flint

○ Extra Blanc
Extra White Flint

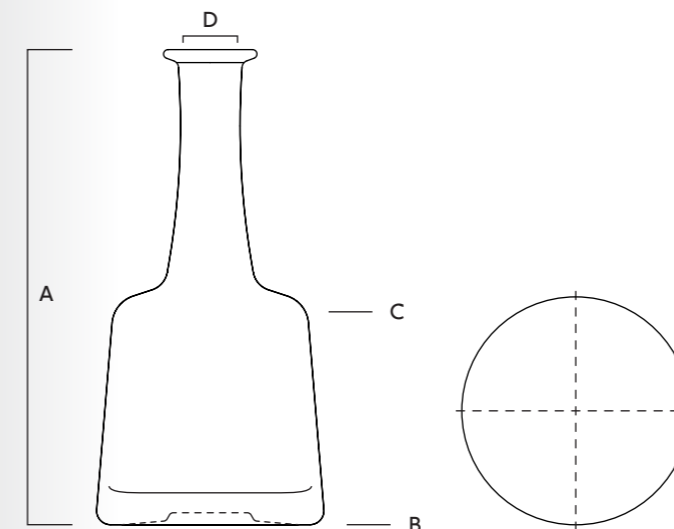

Modèle déposé « Design Saverglass »
Registered "Design Saverglass"

SINGLE

SUPER PREMIUM





176 | 177



SINGLE emprunte son nom de l'univers des whiskies, le terme est souvent synonyme de qualité exceptionnelle dû à son unicité (en provenant d'une seule distillerie «Single Malt» ou d'un seul fût pour le «Single Cask»). Le modèle SINGLE est doté des qualités nécessaires pour répondre à ce désir d'excellence et de sublimation des grandes eaux-de-vie de grain, en prônant les valeurs d'une élégance authentique et d'une âme singulière : haute stature, fût conique, col arrondi et courbe rehaussée d'un col avec renflement (le mollet) puis bague plate extra-haute.

SINGLE borrows its name from the world of whiskey. The term is often synonymous with exceptional quality due to its uniqueness (coming from a single malt distillery or a single cask). SINGLE has the right qualities to fulfill the quest for excellence and enrichment of the great grain spirits by extolling the virtues of authentic elegance and unique character: high stature, tapered body, rounded curvaceous neck enhanced with a slight swell (bulb), and topped with an extra-high flat finish.



Contenance Capacity	35 cl 11.84 oz	37,5 cl 12.68 oz	70 cl 23.67 oz	75 cl 25.36 oz	175 cl 59.18 oz
Référence Reference	5371	5372	3003	3004	4976
Bague Finish	 Plate SB 26	 Plate SB 26	 Plate SB 27,8	 Plate SB 27,8	 Plate SB 32
Poids Weight	461 g 16.26 oz	459 g 16.19 oz	800 g 28.22 oz	800 g 28.22 oz	1380 g 48.68 oz
Hauteur totale [A] Overall height	263,3 mm 10.37 in	263,3 mm 10.37 in	330 mm 12.99 in	330 mm 12.99 in	418 mm 16.46 in
Section maxi [B] Maxi section	64,4 mm 2.54 in	65,9 mm 2.59 in	80 mm 3.15 in	82 mm 3.23 in	107,2 mm 4.22 in
Section mini [C] Mini section	56,4 mm 2.22 in	57,9 mm 2.28 in	69,7 mm 2.74 in	71,8 mm 2.83 in	93,8 mm 3.69 in
Diamètre de débouchage [D] Entrance bore diameter	17,5 mm 0.69 in	17,5 mm 0.69 in	18,5 mm 0.73 in	18,5 mm 0.73 in	21,5 mm 0.85 in
Teinte Glass color	○ Extra Blanc Extra White Flint	○ Extra Blanc Extra White Flint	○ Extra Blanc Extra White Flint	○ Extra Blanc Extra White Flint	○ Extra Blanc Extra White Flint

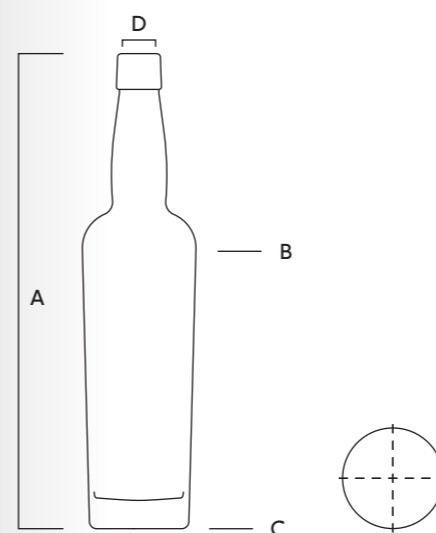



Modèle déposé «Design Saverglass»
Registered "Design Saverglass"



Design épuré, détails subtils et forme compacte offrent au modèle TONIC tous les ingrédients pour devenir un futur « must » des spiritueux super premium. Sa forme minimaliste mi-haute a été pensée pour faciliter la préhension et augmenter son confort d'utilisation. Ses contours se dessinent par petites touches: une bague carnette arrondie délicate fait écho au pontil logé dans la semelle de verre et créé un harmonieux jeu de reflets. Et puisque le style naît des détails, c'est à travers un léger cintrage du corps que TONIC signe son caractère unique. Sa surface d'expression créative conséquente, lui permet de s'accorder à tous les spiritueux.

A discreet design with subtle details and a compact shape provide the TONIC model with all the ingredients to become a must-have for super premium spirits in the future. Its mid-sized minimalist shape has been designed to make it easier and more comfortable to grip. Its contours are shaped by small details: a delicate rounded carnette finish mirrors the punt mark in the glass base and creates a balanced interaction between reflections. And since details are what make the design, a slight pinching in the body gives TONIC its unique character. The resulting creative label panel allows it to be customized for all spirits.



Contenance Capacity	70 cl 23.67 oz	75 cl 25.36 oz
Référence Reference	6041	6181
Bague Finish	 Carnette	 Carnette
Poids Weight	750 g 26.46 oz	764 g 26.95 oz
Hauteur totale [A] Overall height	246,2 mm 9.69 in	246,2 mm 9.69 in
Section maxi [B] Maxi section	82,2 mm 3.24 in	84,5 mm 3.33 in
Section mini [C] Mini section	80,7 mm 3.18 in	83 mm 3.27 in
Diamètre de débouchage [D] Entrance bore diameter	21,5 mm 0.85 in	21,5 mm 0.85 in
Teinte Glass color	○ Extra Blanc Extra White Flint	○ Extra Blanc Extra White Flint

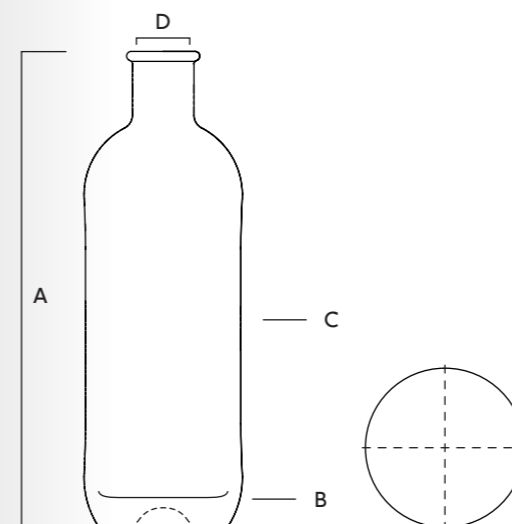

LES AMBIVALENTES 1

SUPER PREMIUM

180 | 181



Cette série de bouteilles joue pleinement la carte du détournement: inspiré de bouteilles de vins bordelaises, chaque modèle se mue à la cause des Spiritueux moyennant un ajustement des contenances, des niveaux utiles et du bouchage.



This range of bottles uses mimicry to its full advantage: inspired by Bordeaux wine bottles, each model is transformed to suit spirits by using different capacities, varying levels of use and different types of closure.



PREMIÈRE SPIRIT



BYBLOS SPIRIT

Contenance Capacity	70 cl 23.67 oz	75 cl 25.36 oz
Référence Reference	2531	2792
Bague Finish	 Plate FA	 Plate FA
Poids Weight	715 g 25.22 oz	730 g 25.75 oz
Hauteur totale [A] Overall height	327,5 mm 12.89 in	328 mm 12.91 in
Section maxi [B] Maxi section	76,2 mm 3 in	80,5 mm 3.17 in
Section mini [C] Mini section	70,2 mm 2.76 in	69,9 mm 2.75 in
Diamètre de débouchage [D] Entrance bore diameter	18,5 mm 0.73 in	18,5 mm 0.73 in
Teinte Glass color	○ Extra Blanc Extra White Flint	○ Extra Blanc Extra White Flint

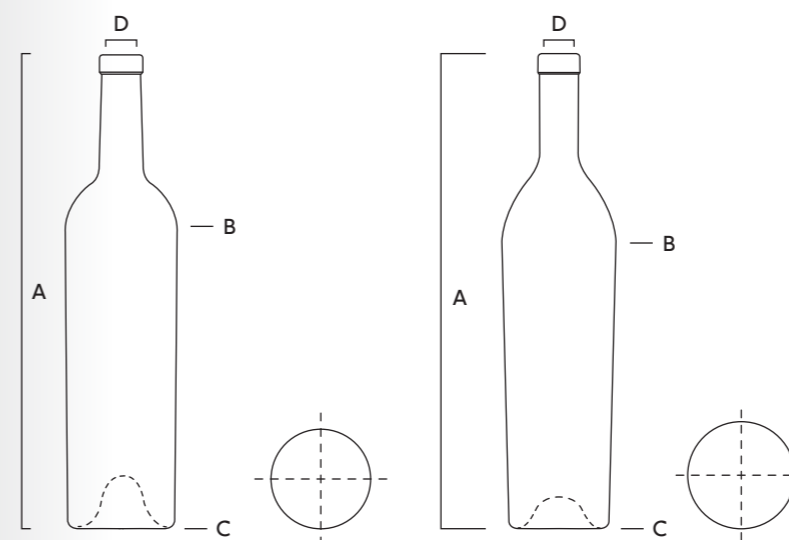

Modèle déposé « Design Saverglass »
Registered "Design Saverglass"

LES EXTRA HAUTES

SUPER PREMIUM

182 | 183



Les élégantes SABA et BAHIA se distinguent par des lignes pures et par l'éclat exceptionnel de leur verre, élevant ces deux formes hautes au rang d'objets ornementaux. Bahia propose plusieurs contenances.

The elegant SABA and BAHIA models stand out from the crowd with their clean lines and exceptional glass radiance, elevating these two tall bottles to the rank of ornamental objects. BAHIA is available in several capacities.



SABA



BAHIA







BAHIA



BAHIA



BAHIA

Contenance Capacity	50 cl 16.91 oz	5 cl 1.69 oz	35 cl 11.84 oz	37.5 cl 12.68 oz	50 cl 16.91 oz
Référence Reference	3109	2498	2312	3742	2413
Bague Finish	 Plate Bouchon à tête 29	 BVP 18 STD	 Plate Bouchon à tête 27	 Plate Bouchon à tête 27	 Plate Bouchon à tête 29
Poids Weight	640 g 22.57 oz	90 g 3.17 oz	520 g 18.34 oz	535 g 18.87 oz	670 g 23.63 oz
Hauteur totale [A] Overall height	343 mm 13.50 in	142 mm 5.59 in	319 mm 12.56 in	319 mm 12.56 in	343 mm 13.50 in
Section maxi [B] Maxi section	74,9 mm 2.95 in	37,4 mm 1.47 in	65,3 mm 2.57 in	65,3 mm 2.57 in	75 mm 2.95 in
Section mini [C] Mini section	55,9 mm 2.2 in	30 mm 1.18 in	49 mm 1.93 in	51,7 mm 2.04 in	56 mm 2.2 in
Diamètre de débouchage [D] Entrance bore diameter	18,5 mm 0.73 in	10,5 mm 0.41 in	17,5 mm 0.69 in	17,5 mm 0.69 in	18,5 mm 0.73 in
Teinte Glass color	○ Extra Blanc Extra White Flint	○ Extra Blanc Extra White Flint	○ Extra Blanc Extra White Flint	○ Extra Blanc Extra White Flint	○ Extra Blanc Extra White Flint

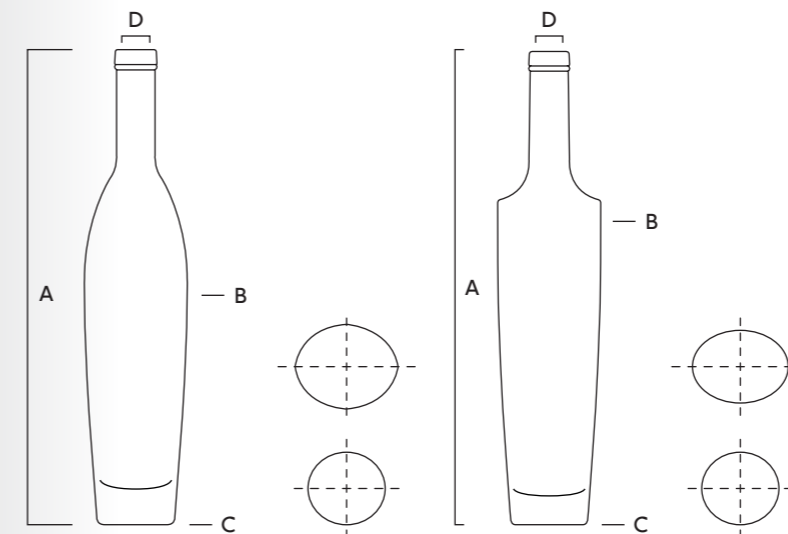

Modèle déposé « Design Saverglass »
Registered "Design Saverglass"

ARIANE 2

PREMIUM





Reprenant quelques codes clé du modèle iconique ARIANE (pureté de la ligne, forme ronde, stature, versatilité...), cette gamme combine ingénieusement élégance et sens de l'économie. Grâce au bouchage à vis type BVP, ARIANE 2 répond en effet aux exigences d'une plus grande compétitivité sans pour autant sacrifier ses qualités esthétiques. La gamme est déclinée dans de très nombreuses contenances.

Using a few key codes of the iconic ARIANE model (clean lines, round shape, stature, versatility, etc.), this range ingeniously combines elegance with a sense of simplicity. Thanks to the BVP screw finish, ARIANE 2 meets the requirements to become more competitive without sacrificing its esthetic qualities. The range is available in an exceptional number of capacities.





ARIANE 2

PREMIUM

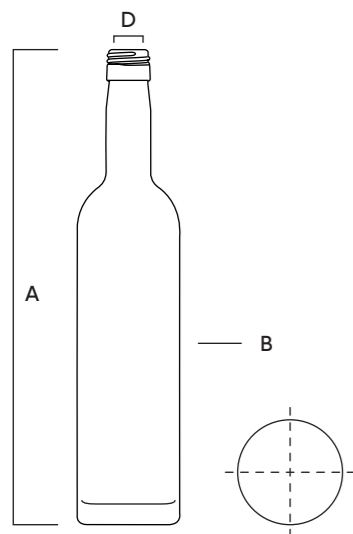

Contenance Capacity	5 cl 1.69 oz	10 cl 3.38 oz	25 cl 8.45 oz	37,5 cl 12.68 oz
Référence Reference	2175	2355	2520	3675
Bague Finish	 BVP 18 STD	 BVP 22 STD SP	 BVP 22 H 30	 BVP 30 H 44
Poids Weight	88 g 3.1 oz	170 g 6.00 oz	300 g 10.58 oz	380 g 13.4 oz
Hauteur totale [A] Overall height	137,3 mm 5.41 in	184,7 mm 7.27 in	228,5 mm 9.00 in	271 mm 10.67 in
Section maxi [B] Maxi section	34,2 mm 1.35 in	40,4 mm 1.59 in	54,2 mm 2.13 in	58,7 mm 2.31 in
Diamètre de débouchage [D] Entrance bore diameter	10,5 mm 0.41 in	14 mm 0.55 in	14 mm 0.55 in	19 mm 0.75 in
Teinte Glass color	○ Extra Blanc Extra White Flint	○ Extra Blanc Extra White Flint	○ Extra Blanc Extra White Flint	○ Extra Blanc Extra White Flint





50 cl 16.91 oz	70 cl 23.67 oz	75 cl 25.36 oz	75 cl 25.36 oz	100 cl 33.82 oz
2519	2582	2583	3673	3674
 BVP 28 H 38	 BVP 30 H 44	 BVP 30 H 44	 BVP 30 H 60	 BVP 30 H 60
550 g 19.4 oz	720 g 25.4 oz	720 g 25.4 oz	680 g 23.99 oz	820 g 28.92 oz
301,2 mm 11.86 in	336,9 mm 13.26 in	336,9 mm 13.26 in	337 mm 13.27 in	346 mm 13.62 in
65,2 mm 2.57 in	72,7 mm 2.86 in	74,6 mm 2.94 in	73,3 mm 2.89 in	83,4 mm 3.28 in
18 mm 0.71 in	19 mm 0.75 in	19 mm 0.75 in	19 mm 0.75 in	19 mm 0.75 in
○ Extra Blanc Extra White Flint	○ Extra Blanc Extra White Flint	○ Extra Blanc Extra White Flint	○ Extra Blanc Extra White Flint	○ Extra Blanc Extra White Flint



BOSTON est une bouteille carrée et fonctionnelle. Elle se caractérise par une section à pans coupés de largeur progressive qui singularisent les amples surfaces décorables surmontées d'épaules saillantes. Objectif atteint sur les terrains fonctionnels et économiques. Ce modèle compact à bouchage à vis s'offre à un large champ d'applications-produit.

BOSTON is a square, functional bottle. It is characterized by a cross-section comprising panels of varying width that accentuate the ample decorative surfaces, topped by strong shoulders. It successfully achieves functionality and modesty. This compact model with screw finish is available for a wide range of product applications.

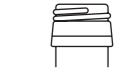

Contenance Capacity	5 cl 1.69 oz	50 cl 16.91 oz	70 cl 23.67 oz	75 cl 25.36 oz	100 cl 33.82 oz	175 cl 59.18 oz
Référence Reference	2669	2458	2447	2572	2838	4362
Bague Finish	 BVP 18 STD	 BVP 28 STD	 BVP 31,5 H 60	 BVP 31,5 H 60	 BVP 31 H 60	 BVP 36 H 52
Poids Weight	70 g 2.47 oz	510 g 17.99 oz	710 g 25.04 oz	710 g 25.04 oz	880 g 31.04 oz	1555 g 54.85 oz
Hauteur totale [A] Overall height	117,6 mm 4.63 in	241,4 mm 9.50 in	274,5 mm 10.81 in	274,5 mm 10.81 in	305,2 mm 12.02 in	311 mm 12.24 in
Section maxi [B] Maxi section	31,6 × 31,6 mm 1.24 × 1.24 in	66 × 66 mm 2.6 × 2.6 in	73,4 × 73,4 mm 2.89 × 2.89 in	75,6 × 75,6 mm 2.98 × 2.98 in	82,7 × 82,7 mm 3.26 × 3.26 in	111,4 × 111,4 mm 4.39 × 4.39 in
Diamètre de débouchage [D] Entrance bore diameter	10,5 mm 0.41 in	18 mm 0.71 in	20,5 mm 0.81 in	20,5 mm 0.81 in	19 mm 0.75 in	25 mm 0.98 in
Teinte Glass color	○ Extra Blanc Extra White Flint	○ Extra Blanc Extra White Flint	○ Extra Blanc Extra White Flint	○ Extra Blanc Extra White Flint	○ Extra Blanc Extra White Flint	○ Extra Blanc Extra White Flint

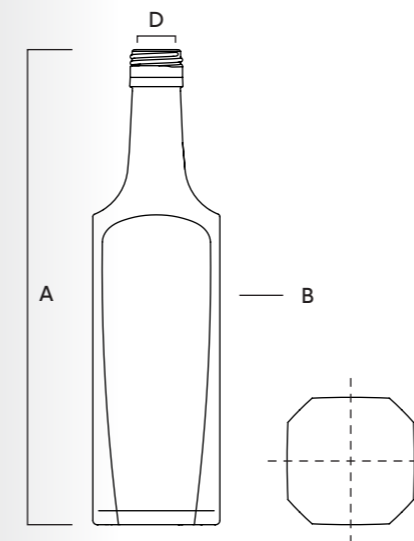







BOTANIC oscille entre harmonie, caractère et versatilité. Son élégante silhouette est due à sa forme basse et cylindrique, son épaulement au tracé de coupole de cathédrale florentine, et sa piqûre en forme de cône aux bords adoucis. Enfin, son col conique, surmonté d'une bague carnette vive à l'ancienne, lui donne un aspect rétro tant apprécié.

BOTANIC fluctuates between harmony, character and versatility. Its elegant silhouette is formed by its short cylindrical profile, a shoulder that suggests the outline of the dome on Florence Cathedral and a cone-shaped punt with softened edges. Its tapered neck, crowned with a bold old-fashioned carnette finish, gives the bottle a popular retro appearance.



Contenance Capacity	70 cl 23.67 oz	70 cl 23.67 oz	75 cl 25.36 oz	75 cl 25.36 oz
Référence Reference	5589	5589	5593	5593
Bague Finish	 Carnette	 GPI 400/33	 Carnette	 GPI 400/33
Poids Weight	545 g 19.22 oz	564 g 19.89 oz	548 g 19.33 oz	567 g 20.00 oz
Hauteur totale [A] Overall height	196,6 mm 7.74 in	206,4 mm 8.13 in	196,6 mm 7.74 in	206,4 mm 8.13 in
Section maxi [B] Maxi section	98 mm 3.86 in	98 mm 3.86 in	100,7 mm 3.96 in	100,7 mm 3.96 in
Diamètre de débouchage [D] Entrance bore diameter	21,5 mm 0.85 in	21,5 mm 0.85 in	21,5 mm 0.85 in	21,5 mm 0.85 in
Teinte Glass color	○ Extra Blanc Extra White Flint	○ Extra Blanc Extra White Flint	○ Extra Blanc Extra White Flint	○ Extra Blanc Extra White Flint

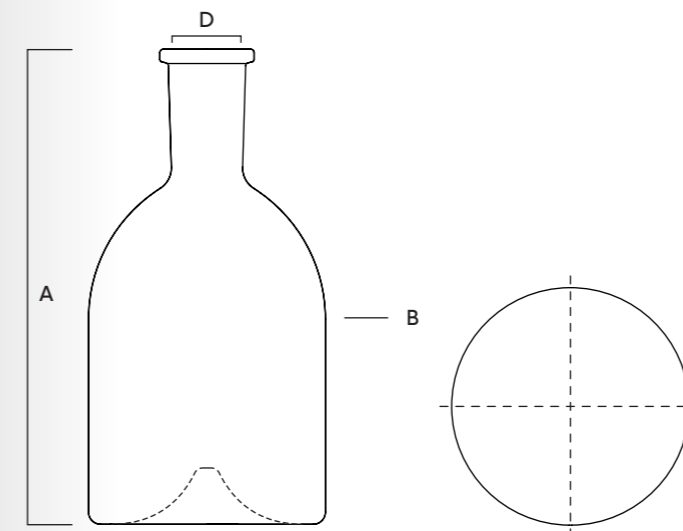

DISTIL'ER

PREMIUM

192 | 193



DISTIL'ER puise son inspiration des flacons d'officine d'antan. Sa piqûre à l'angle saillant arrondi innove et répond par un jeu de symétrie harmonieux à l'épaule. Cette particularité du design la différencie fortement. Dotée d'une large surface décorable, elle laisse à chacun l'opportunité de la personnaliser facilement. Son poids raisonnable et ses différents bouchages (bague plate ou à vis) s'ajoutent à ses nombreux atouts. DISTIL'ER affiche un design de caractère, au cachet certain et à l'esprit « hand-made ».

DISTIL'ER draws inspiration from the dispensary bottles of yesteryear. Its sharp-angled punt with rounded edges innovates and is reflected in the shoulder's well-balanced symmetry. This distinctive design feature makes it a real stand-out bottle. Its large decorative surface makes it easy for anyone to customize. Its moderate weight and various finishes (flat or screw) add to its many strengths. DISTIL'ER boasts a design with character and a distinct style, giving the impression of having been handcrafted.



Contenance Capacity	50 cl 16.91 oz	70 cl 23.67 oz	70 cl 23.67 oz	75 cl 25.36 oz	75 cl 25.36 oz
Référence Reference	6039	5394	5394	5395	5395
Bague Finish	 Plate	 Plate	 GPI 400/33	 Plate	 GPI 400/33
Poids Weight	448 g 15.8 oz	640 g 22.57 oz	639 g 22.54 oz	640 g 22.57 oz	639 g 22.54 oz
Hauteur totale [A] Overall height	209 mm 8.23 in	234 mm 9.21 in	235,2 mm 9.26 in	234 mm 9.21 in	235,2 mm 9.26 in
Section maxi [B] Maxi section	78,4 mm 3.09 in	87,9 mm 3.46 in	87,9 mm 3.46 in	90,3 mm 3.56 in	90,3 mm 3.56 in
Diamètre de débouchage [D] Entrance bore diameter	18,5 mm 0.73 in	21,5 mm 0.85 in	21,5 mm 0.85 in	21,5 mm 0.85 in	21,5 mm 0.85 in
Teinte Glass color	○ Extra Blanc Extra White Flint	○ Extra Blanc Extra White Flint	○ Extra Blanc Extra White Flint	○ Extra Blanc Extra White Flint	○ Extra Blanc Extra White Flint

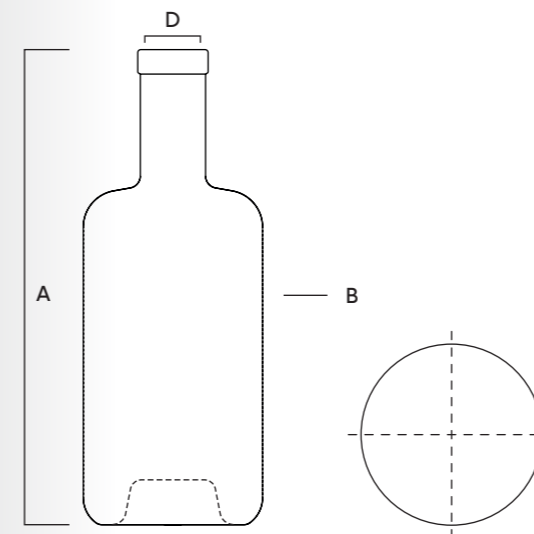

Modèle déposé « Design Saverglass »
Registered "Design Saverglass"

FORTY-SIX

PREMIUM





194 | 195



Inspirée des formes originelles des bouteilles de Bourbons et de Whiskeys américains, la bouteille FORTY-SIX renouvelle le genre. De section ronde, cette forme conique mi-haute offre une large surface décorable qui la rend facilement personnalisable. Ses atouts supplémentaires sont caractérisés par une épaule généreuse, une piqûre sphérique de taille contenue et un bulbe adouci distinctif. FORTY-SIX s'adresse à toutes les catégories de spiritueux, et notamment aux whiskeys et aux rhums.

Inspired by the original shapes of American bourbon and whiskey bottles, the FORTY-SIX is a fresh addition to this type of bottle. With a round cross-section, this medium-sized tapered body provides a large decorative surface for easy customization. Its additional strengths lie on its generous shoulder, modestly sized spherical punt, and distinctive soft-edged bulb. FORTY-SIX is intended to be used with all kinds of spirits, particularly whiskeys and rums.



Contenance Capacity	70 cl 23.67 oz	70 cl 23.67 oz	75 cl 25.36 oz	75 cl 25.36 oz
Référence Reference	5343	5343	5344	5344
Bague Finish	 Plate	 GPI 400/28	 Plate	 GPI 400/28
Poids Weight	707 g 24.94 oz	698 g 24.62 oz	707 g 24.94 oz	699 g 24.66 oz
Hauteur totale [A] Overall height	272 mm 10.71 in	271,2 mm 10.68 in	272 mm 10.71 in	271,2 mm 10.68 in
Section maxi [B] Maxi section	87,6 mm 3.45 in	87,6 mm 3.45 in	89,9 mm 3.54 in	89,9 mm 3.54 in
Section mini [C] Mini section	76,9 mm 3.03 in	76,9 mm 3.03 in	79,2 mm 3.12 in	79,2 mm 3.12 in
Diamètre de débouchage [D] Entrance bore diameter	18,5 mm 0.73 in	18,5 mm 0.73 in	18,5 mm 0.73 in	18,5 mm 0.73 in
Teinte Glass color	○ Extra Blanc Extra White Flint	○ Extra Blanc Extra White Flint	○ Extra Blanc Extra White Flint	○ Extra Blanc Extra White Flint

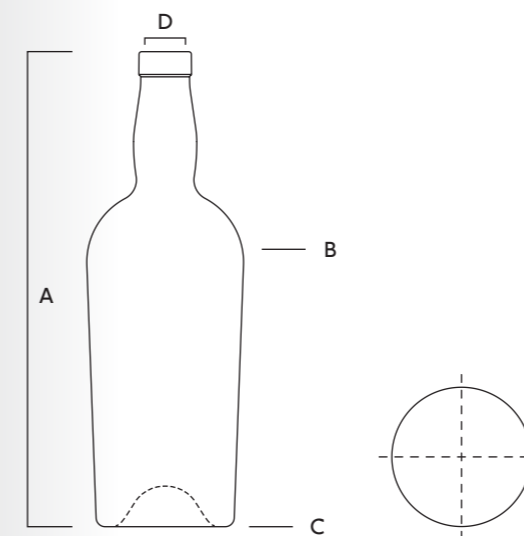

Modèle déposé « Design Saverglass »
Registered "Design Saverglass"

INSOLENCE SPIRIT

PREMIUM

196 | 197



INSOLENCE SPIRIT affiche une silhouette fluide, vivace et longiligne. Dotée d'un fort tempérament, sa singularité réside dans sa forme conique inversée et sa piqûre carrée qui fait harmonieusement écho à son épaulement. Impertinente, audacieuse et à la fois intemporelle, INSOLENCE SPIRIT séduit par son élégance et un style affirmé, reconnaissable entre tous.

INSOLENCE SPIRIT boasts a fluid, bold and sleek silhouette. With a strong personality, its unique character lies in its inverted tapered and square punt, which is perfectly reflected in the shape of its shoulder. Sassy, daring and timeless all at the same time, INSOLENCE SPIRIT is seductive with its elegance and distinct style, making it stand out from the crowd.



Contenance
Capacity

70 cl
23.67 oz

75 cl
25.36 oz

Référence
Reference

6125

6186

Bague
Finish



Poids
Weight

651 g
22.96 oz

651 g
22.96 oz

Hauteur
totale [A]
Overall
height

328 mm
12.91 in

328 mm
12.91 in

Section
maxi [B]
Maxi
section

78,4 mm
3.09 in

80,3 mm
3.16 in

Section
mini [C]
Mini
section

67 mm
2.64 in

68,9 mm
2.71 in

Diamètre de
débouchage
[D] Entrance
bore diameter

18,5 mm
0.73 in

18,5 mm
0.73 in

Teinte
Glass color

○ Extra Blanc
Extra White Flint

○ Extra Blanc
Extra White Flint

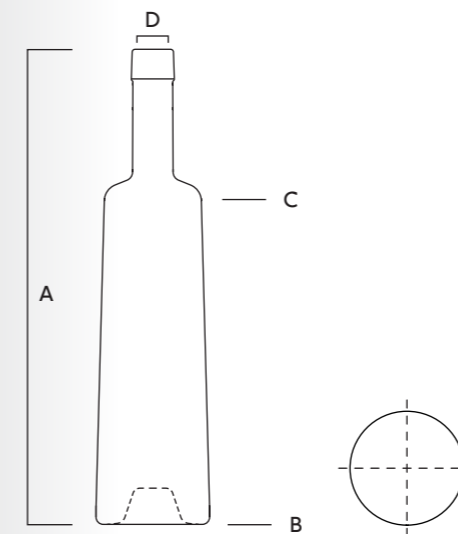

Modèle déposé « Design Saverglass »
Registered "Design Saverglass"

LA MILLÉSIME

PREMIUM

198 | 199



LA MILLESIME est un contenant qui revisite élégamment la forme traditionnelle de la coognaçaise et la modernise. Conçue pour les alcools de grande qualité ainsi que pour des élixirs millésimés, son profil élancé (320 mm) et conique la caractérise. Elle se dote également d'épaules aux proportions harmonieuses. Enfin, sa bague plate spirit et sa piquère épurée en forme de dôme, viennent compléter, dans sa version classique, l'allure gracieuse du flacon. Deux autres versions agrémentées de piquères gravées originales sont proposées : LA MILLESIME « FALLING STAR » et LA MILLESIME « GALAXY ».

LA MILLESIME is a container that elegantly revisits the traditional shape of cognac bottles and gives it a modern twist. This model is designed for premium spirits and vintage liqueurs, and it is characterized by its slender (320 mm) and tapered profile. It also boasts elegantly proportioned shoulders, finished off with a flat spirit finish and simple dome-shaped punt, complementing the graceful appearance of the bottle in its classic form. Two versions adorned with original etched punts are also available: LA MILLESIME FALLING STAR and LA MILLESIME GALAXY.



Contenance Capacity	70 cl 23.67 oz	70 cl 23.67 oz	70 cl 23.67 oz	75 cl 25.36 oz	75 cl 25.36 oz	75 cl 25.36 oz
Référence Reference	6047	6055	6054	6091	6093	6092
Bague Finish	 Plate	 Plate	 Plate	 Plate	 Plate	 Plate
Poids Weight	677 g 23.88 oz	678 g 23.92 oz	679 g 23.95 oz	682 g 24.06 oz	683 g 24.09 oz	684 g 24.13 oz
Hauteur totale [A] Overall height	320 mm 12.60 in	320 mm 12.60 in	320 mm 12.60 in	320 mm 12.60 in	320 mm 12.60 in	320 mm 12.60 in
Section maxi [B] Maxi section	77 mm 3.03 in	77 mm 3.03 in	77 mm 3.03 in	79,2 mm 3.12 in	79,2 mm 3.12 in	79,2 mm 3.12 in
Section mini [C] Mini section	71 mm 2.8 in	71 mm 2.8 in	71 mm 2.8 in	73,2 mm 2.88 in	73,2 mm 2.88 in	73,2 mm 2.88 in
Diamètre de débouchage [D] Entrance bore diameter	18,5 mm 0.73 in	18,5 mm 0.73 in	18,5 mm 0.73 in	18,5 mm 0.73 in	18,5 mm 0.73 in	18,5 mm 0.73 in
Teinte Glass color	○ Extra Blanc Extra White Flint	○ Extra Blanc Extra White Flint	○ Extra Blanc Extra White Flint	○ Extra Blanc Extra White Flint	○ Extra Blanc Extra White Flint	○ Extra Blanc Extra White Flint

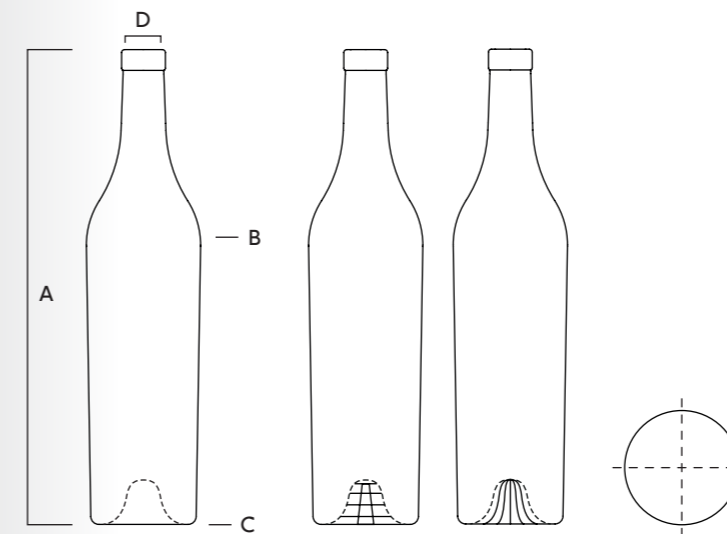

Modèle déposé « Design Saverglass »
Registered "Design Saverglass"



MIXOLOGIST s'approprié les codes des flacons anciens pour mieux les détourner et laisser place à une ligne contemporaine et sophistiquée. Ce modèle se singularise par sa forme basse cylindrique et sa légère conicité. Sa piqûre différenciante, telle une montagne plane en son sommet au milieu d'une grande étendue, fait écho à son épaulement qui suit des contours ap-
prochants. Enfin, se distingue également par son col évasé ac-
centué, surplombé d'une bague carnette vive et fine.

MIXOLOGIST borrows codes from old bottles and subverts them to great effect, producing a contemporary and sophisticated profile. This model sets itself apart with its short cylindrical shape and slight taper. Its distinctive punt, remi-
niscent of a table mountain in the middle of a vast expanse, echoes the shoulder shaped with a similar contour. Last but not least, the bottle also stands out with its accentuated flared neck, crowned by a fine bold carnette finish.



Contenance Capacity	37,5 cl 12.68 oz	50 cl 16.91 oz	70 cl 23.67 oz	70 cl 23.67 oz	75 cl 25.36 oz	75 cl 25.36 oz
Référence Reference	6025	6322	5594	5594	5599	5599
Bague Finish	 Carnette	 Carnette	 Carnette	 GPI 400/38	 Carnette	 GPI 400/38
Poids Weight	315 g 11.11 oz	385 g 13.58 oz	500 g 17.64 oz	500 g 17.64 oz	510 g 17.99 oz	510 g 17.99 oz
Hauteur totale [A] Overall height	157,7 mm 6.21 in	172 mm 6.77 in	189,8 mm 7.47 in	200,1 mm 7.88 in	189,8 mm 7.47 in	200,1 mm 7.88 in
Section maxi [B] Maxi section	78,2 mm 3.08 in	85,9 mm 3.38 in	95 mm 3.74 in	95 mm 3.74 in	98,2 mm 3.87 in	98,2 mm 3.87 in
Section mini [C] Mini section	74,5 mm 2.93 in	81,9 mm 3.22 in	90,4 mm 3.56 in	90,4 mm 3.56 in	93,4 mm 3.68 in	93,4 mm 3.68 in
Diamètre de débouchage [D] Entrance bore diameter	23 mm 0.91 in	26 mm 1.02 in	26 mm 1.02 in	24 mm 0.94 in	26 mm 1.02 in	24 mm 0.94 in
Teinte Glass color	○ Extra Blanc Extra White Flint	○ Extra Blanc Extra White Flint	○ Extra Blanc Extra White Flint	○ Extra Blanc Extra White Flint	○ Extra Blanc Extra White Flint	○ Extra Blanc Extra White Flint

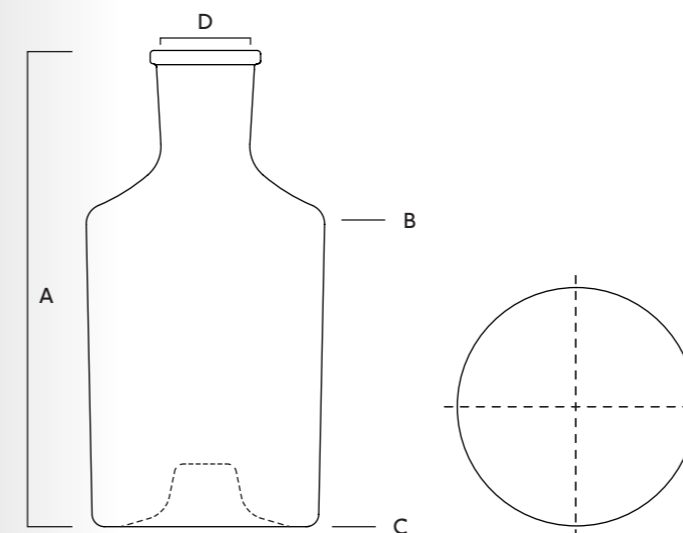

Modèle déposé « Design Saverglass »
Registered "Design Saverglass"

NORMANDIE

PREMIUM





202 | 203



NORMANDIE réinterprète de manière surprenante et originale un classique bien Français. Si sa silhouette revendique assurément son héritage normand, elle se singularise cependant par son col long et sa bague extra-haute qui en font le conditionnement privilégié des très vieux Calvados. Disponible en verre blanc (sur commande), ce modèle très flexible s'adapte à tous types de contenus.

NORMANDIE reinterprets a thoroughly French classic in a surprising and original way. While its silhouette undoubtedly asserts its Normandy heritage, it sets itself apart with its long neck and extra-high finish, making it the preferred container for vintage Calvados. This very versatile model is suitable for all types of content and is available in white glass (to order).



Contenance Capacity	35 cl 11.84 oz	70 cl 23.67 oz	75 cl 25.36 oz	150 cl 50.72 oz
Référence Reference	1349	0149	1977	1263
Bague Finish	 Plate	 Plate	 Plate	 Plate
Poids Weight	430 g 15.17 oz	690 g 24.34 oz	615 g 21.69 oz	1250 g 44.09 oz
Hauteur totale [A] Overall height	232 mm 9.13 in	281,5 mm 11.08 in	281,5 mm 11.08 in	334,5 mm 13.17 in
Section maxi [B] Maxi section	76 mm 2.99 in	94 mm 3.7 in	94 mm 3.7 in	128,2 mm 5.05 in
Section mini [C] Mini section	67 mm 2.64 in	83 mm 3.27 in	83 mm 3.27 in	107,5 mm 4.23 in
Diamètre de débouchage [D] Entrance bore diameter	18,5 mm 0.73 in	18,5 mm 0.73 in	18,5 mm 0.73 in	28 mm 1.1 in
Teinte Glass color	○ Extra Blanc Extra White Flint ● Antique Antique Green	○ Extra Blanc Extra White Flint ● Antique Antique Green	○ Extra Blanc Extra White Flint ● Antique Antique Green	○ Extra Blanc Extra White Flint ● Antique Antique Green

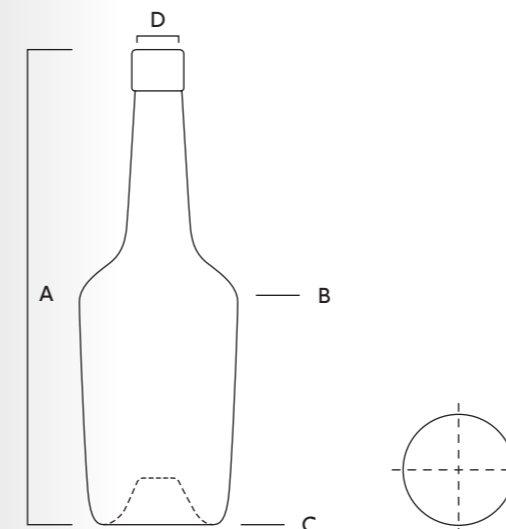

OXYGEN

PREMIUM



Aérienne et pure, OXYGEN symbolise le modèle versatile par excellence. Sa forme conique mi-haute, son épaulement délicatement arrondi et son élégante semelle de verre esquissent une bouteille parfaitement adaptée à tous types de spiritueux. Ce flacon aux lignes minimalistes, offre ergonomie et préhension aisée et se prête, enfin, aisément à la personnalisation.

Simple and airy, OXYGEN is the ultimate model in terms of versatility. Its mid-sized tapered shape, delicately rounded shoulder, and elegant glass base shape a bottle that is perfectly suited to all types of spirits. This minimalist bottle is easy to customize and provides a shape that is ergonomic and easy to grip.

OXYGEN

PREMIUM



Contenance Capacity	5 cl 1.69 oz	20 cl 6.76 oz	20 cl 6.76 oz	37,5 cl 12.68 oz	50 cl 16.91 oz
Référence Reference	5337	5811	5811	5443	5488
Bague Finish	 BVP 18 STD	 Plate	 GPI 400/28	 Plate	 Plate
Poids Weight	90 g 3.17 oz	272 g 9.59 oz	275 g 9.7 oz	430 g 15.17 oz	560 g 19.75 oz
Hauteur totale [A] Overall height	117,4 mm 4.62 in	171,3 mm 6.74 in	175,8 mm 6.92 in	207,1 mm 8.15 in	231,6 mm 9.12 in
Section maxi [B] Maxi section	37,2 mm 1.46 in	57,1 mm 2.25 in	57,1 mm 2.25 in	69 mm 2.72 in	75 mm 2.95 in
Section mini [C] Mini section	35,7 mm 1.41 in	54,8 mm 2.16 in	54,8 mm 2.16 in	66,2 mm 2.61 in	71,9 mm 2.83 in
Diamètre de débouchage [D] Entrance bore diameter	10,5 mm 0.41 in	17,5 mm 0.69 in	18,5 mm 0.73 in	18,5 mm 0.73 in	21,5 mm 0.85 in
Teinte Glass color	○ Extra Blanc Extra White Flint	○ Extra Blanc Extra White Flint	○ Extra Blanc Extra White Flint	○ Extra Blanc Extra White Flint	○ Extra Blanc Extra White Flint

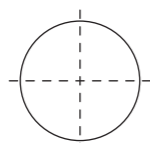
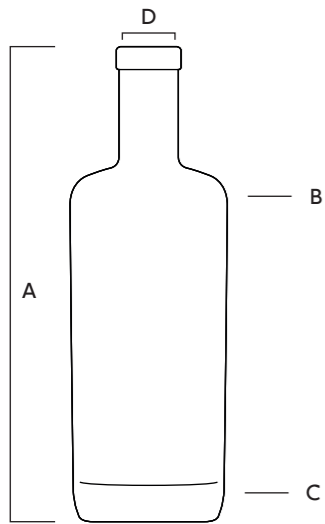

50 cl 16.91 oz	70 cl 23.67 oz	70 cl 23.67 oz	75 cl 25.36 oz	75 cl 25.36 oz	100 cl 33.82 oz	100 cl 33.82 oz
5488	4841	4841	4842	4842	5420	5420
 GPI 400/33	 Plate	 GPI 400/33	 Plate	 GPI 400/33	 Plate	 GPI 400/33
550 g 19.4 oz	780 g 27.51 oz	770 g 27.16 oz	780 g 27.51 oz	770 g 27.16 oz	953 g 33.62 oz	943 g 33.26 oz
232,6 mm 9.16 in	258 mm 10.16 in	259,2 mm 10.20 in	258 mm 10.16 in	259,2 mm 10.20 in	280,6 mm 11.05 in	281,8 mm 11.09 in
75 mm 2.95 in	84,2 mm 3.31 in	84,2 mm 3.31 in	86,3 mm 3.4 in	86,3 mm 3.4 in	94,3 mm 3.71 in	94,3 mm 3.71 in
71,9 mm 2.83 in	80,7 mm 3.18 in	80,7 mm 3.18 in	82,8 mm 3.26 in	82,8 mm 3.26 in	90,5 mm 3.56 in	90,5 mm 3.56 in
20,7 mm 0.81 in	21,5 mm 0.85 in	21,5 mm 0.85 in	21,5 mm 0.85 in	21,5 mm 0.85 in	21,5 mm 0.85 in	20,7 mm 0.81 in
○ Extra Blanc Extra White Flint	○ Extra Blanc Extra White Flint	○ Extra Blanc Extra White Flint	○ Extra Blanc Extra White Flint	○ Extra Blanc Extra White Flint	○ Extra Blanc Extra White Flint	○ Extra Blanc Extra White Flint

TIME SQUARE

PREMIUM

208 | 209



Ce modèle puise son inspiration du plan géométrique du quartier de Manhattan, à New-York, et de sa célèbre place aux multiples intersections! TIME SQUARE est un modèle décliné en versions basse et haute, dont la particularité est de présenter une section carrée, agrémentée de 4 pans coupés dont les lignes finissent par se croiser et délimitent de belles surfaces décorables! Le modèle, assez léger étant donné sa configuration, présente le double avantage suivant: fonctionnalité et compétitivité prix.

This model draws inspiration from the geometric patterns on maps of Manhattan, New York, and its famous intersecting roads. TIME SQUARE is available in tall and short versions. The bottle's special feature is its square cross-section, embellished with four cutaway corners comprising lines that intersect and outline beautiful decorative spaces. This model, which is fairly lightweight given its dimensions, has the double advantage of functionality and price competitiveness.

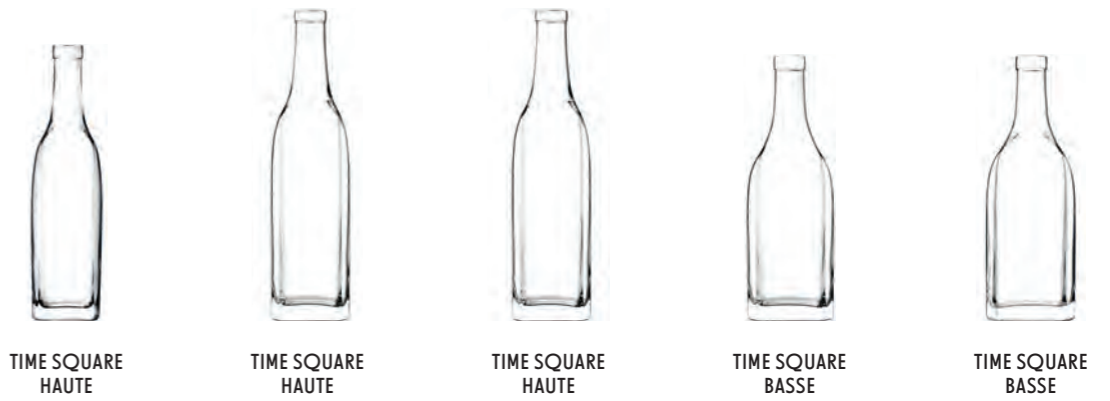

Contenance Capacity	50 cl 16.91 oz	70 cl 23.67 oz	75 cl 25.36 oz	70 cl 23.67 oz	75 cl 25.36 oz
Référence Reference	5360	4836	4837	4863	4864
Bague Finish	 Plate	 Plate	 Plate	 Plate	 Plate
Poids Weight	520 g 18.34 oz	700 g 24.69 oz	745 g 26.28 oz	770 g 27.16 oz	770 g 27.16 oz
Hauteur totale [A] Overall height	260 mm 10.24 in	293,5 mm 11.56 in	293,5 mm 11.56 in	250,3 mm 9.85 in	250,3 mm 9.85 in
Section maxi [B] Maxi section	66 × 66 mm 2.6 × 2.6 in	73 × 73 mm 2.87 × 2.87 in	75 × 75 mm 2.95 × 2.95 in	81 × 81 mm 3.19 × 3.19 in	82,9 × 82,9 mm 3.26 × 3.26 in
Section mini [C] Mini section	62,1 × 62,1 mm 2.44 × 2.44 in	68,9 × 68,9 mm 2.71 × 2.71 in	70,6 × 70,6 mm 2.78 × 2.78 in	79,9 × 79,9 mm 3.15 × 3.15 in	81,8 × 81,8 mm 3.22 × 3.22 in
Diamètre de débouchage [D] Entrance bore diameter	17,5 mm 0.69 in	18,5 mm 0.73 in	18,5 mm 0.73 in	18,5 mm 0.73 in	18,5 mm 0.73 in
Teinte Glass color	○ Extra Blanc Extra White Flint	○ Extra Blanc Extra White Flint	○ Extra Blanc Extra White Flint	○ Extra Blanc Extra White Flint	○ Extra Blanc Extra White Flint

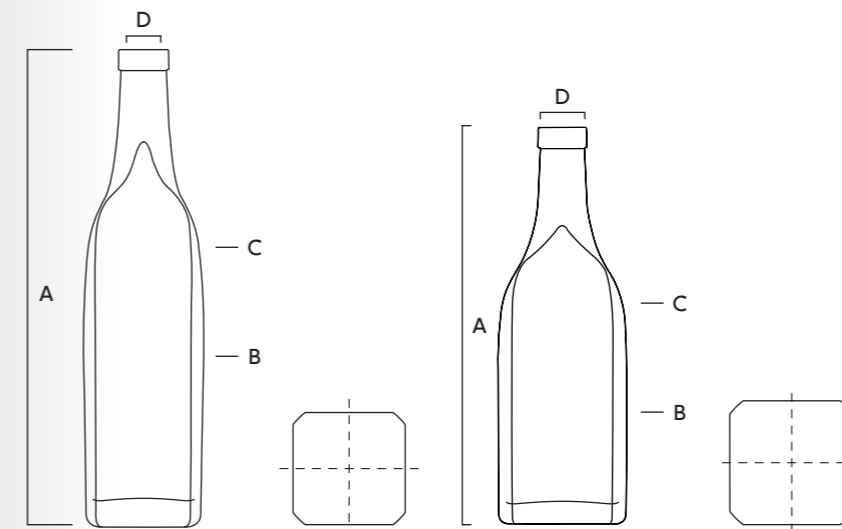

Modèle déposé « Design Saverglass »
Registered "Design Saverglass"

MARC GRAND CRU

PREMIUM

210 | 211



MARC GRAND CRU joue la carte du détournement d'emploi: inspirée d'une bouteille de Vins, elle se met au service de la cause des Spiritueux moyennant un ajustement de sa contenance, de son niveau utile, ainsi qu'une adaptation de son bouchage.

MARC GRAND CRU plays on the idea that things are not always as they appear: its altered capacity, filling level and adapted closure give it a unique design tailored to spirits yet modeled on a traditional wine bottle.



Contenance
Capacity

70 cl
23.67 oz

Référence
Reference

0233

Bague
Finish



Carrée

Poids
Weight

820 g
28.92 oz

Hauteur
totale [A]
Overall
height

295,8 mm
11.65 in

Section
maxi [B]
Maxi
section

92,7 mm
3.65 in

Section
mini [C]
Mini
section

91,7 mm
3.61 in

Diamètre de
débouchage
[D] Entrance
bore diameter

17,5 mm
0.69 in

Teinte
Glass color

● Antique
Antique Green

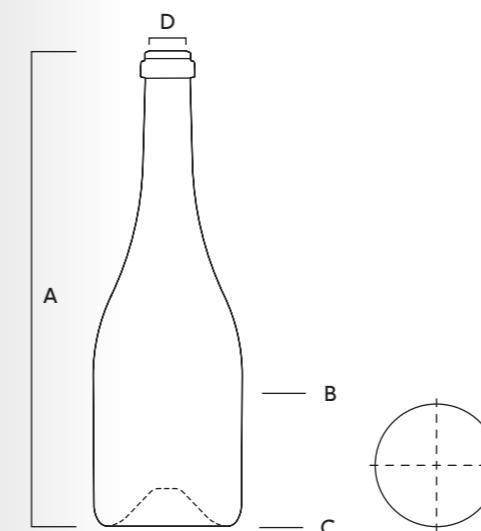

Modèle déposé « Design Saverglass »
Registered "Design Saverglass"

FLÛTE ALTUS SPIRIT

PREMIUM

212 | 213



Par son nom d'origine latine qui signifie « haut », ALTUS se caractérise par une jolie silhouette longiligne et raffinée. Cette bouteille cylindrique au charme discret s'adapte à tous types de contenus, depuis les spiritueux jusqu'aux vins tranquilles.

ALTUS takes its name from the Latin for "high" and is characterized by a beautifully sleek and sophisticated silhouette. This cylindrical bottle has a subtle charm and adapts to all types of content, from spirits to still wines.



Contenance Capacity	3 cl 1.01 oz	37,5 cl 12.68 oz	50 cl 16.91 oz	70 cl 23.67 oz	75 cl 25.36 oz	150 cl 50.72 oz
Référence Reference	1177	2079	2080	2191	2081	0719
Bague Finish	 BVP 18 STD	 Plate FA	 Plate FA	 Plate FA	 Plate FA	 Plate FA
Poids Weight	60 g 2.12 oz	420 g 14.81 oz	538 g 18.98 oz	575 g 20.28 oz	585 g 20.63 oz	1230 g 43.39 oz
Hauteur totale [A] Overall height	117,6 mm 4.63 in	305 mm 12.01 in	336 mm 13.23 in	357,3 mm 14.07 in	357,3 mm 14.07 in	478 mm 18.82 in
Section maxi [B] Maxi section	30,5 mm 1.2 in	61,3 mm 2.41 in	68,1 mm 2.68 in	75,4 mm 2.97 in	77,7 mm 3.06 in	93,5 mm 3.68 in
Diamètre de débouchage [D] Entrance bore diameter	10,5 mm 0.41 in	18,5 mm 0.73 in	18,5 mm 0.73 in	18,5 mm 0.73 in	18,5 mm 0.73 in	18,5 mm 0.73 in
Teinte Glass color	○ Extra Blanc Extra White Flint	○ Extra Blanc Extra White Flint	○ Extra Blanc Extra White Flint	○ Extra Blanc Extra White Flint	○ Extra Blanc Extra White Flint	○ Extra Blanc Extra White Flint

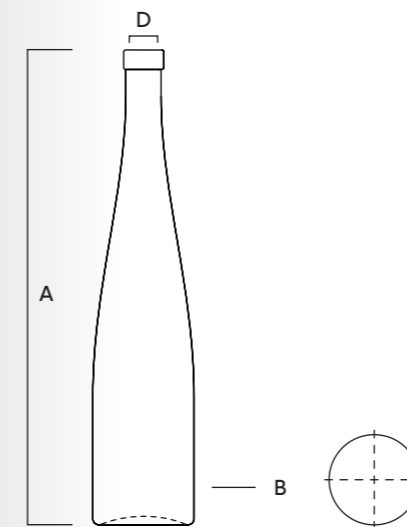

Modèle déposé « Design Saverglass »
Registered "Design Saverglass"



A mi-chemin entre la bouteille et la carafe, cette forme organique empreinte ses contours à un beau galet arrondi. Sa section singulière ni ovale ni rectangulaire, ainsi que la répartition du verre dans la semelle contribuent au caractère distinctif du modèle INA. Ses larges surfaces décorables offrent un champ quasi-infini de personnalisations.

Halfway between a bottle and a decanter, the contours of this organic shape give the impression of a perfectly rounded pebble. The INA model boasts a distinct character thanks to its unique cross-section, which is neither oval or rectangular, and the spread of the glass in the base. Its large decorative surfaces offer almost infinite scope for customization.



Contenance
Capacity

70 cl
23.67 oz

75 cl
23.36 oz

Référence
Reference

4639

4640

Bague
Finish



Plate



Plate

Poids
Weight

712 g
25.11 oz

720 g
25.4 oz

Hauteur
totale [A]
Overall
height

235,1 mm
9.26 in

235,1 mm
9.26 in

Section
maxi [B]
Maxi
section

110 × 65,9 mm
4.33 × 2.59 in

110 × 69,4 mm
4.33 × 2.73 in

Diamètre de
débouchage
[D] Entrance
bore diameter

21,5 mm
0.85 in

21,5 mm
0.85 in

Teinte
Glass color

○ Extra Blanc
Extra White Flint

○ Extra Blanc
Extra White Flint

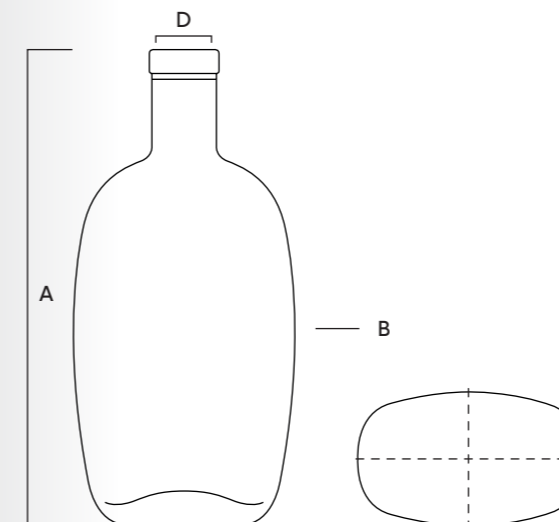

Modèle déposé « Design Saverglass »
Registered "Design Saverglass"

TAM-TAM

PREMIUM

216 | 217



Interprétation quasi-cosmétique de la forme trapézoïdale du «tam-tam africain», le modèle TAM-TAM offre un design percutant et élégant qui saura résonner auprès des spiritueux et liqueurs en quête de différenciation et d'un positionnement résolument super premium. Son style décalé résulte de sa silhouette élancée, de son épaule horizontale étroite et d'un col court conçu pour l'adaptation de capsules à vis préformées (type GPI), notamment.

An almost superficial interpretation of the African tam-tam drum's trapezoid shape, the TAM-TAM model offers a striking and elegant design that will resonate with spirits and liqueurs seeking distinction and resolutely super premium positioning. Its offbeat style is the result of its slender silhouette, narrow horizontal shoulder, and short neck that is designed to be suitable for preformed screw caps (GPI type) in particular.



Contenance
Capacity

70 cl
23.67 oz

75 cl
25.36 oz

Référence
Reference

4126

4127

Bague
Finish



GPI 400/33



GPI 400/33

Poids
Weight

650 g
22.93 oz

660 g
23.28 oz

Hauteur
totale [A]
Overall
height

278,3 mm
10.96 in

278,3 mm
10.96 in

Section
maxi [B]
Maxi
section

78,8 mm
3.1 in

80,9 mm
3.19 in

Section
mini [C]
Mini
section

61,4 mm
2.42 in

63,5 mm
2.5 in

Diamètre de
débouchage
[D] Entrance
bore diameter

21,5 mm
0.85 in

21,5 mm
0.85 in

Teinte
Glass color

○ Extra Blanc
Extra White Flint

○ Extra Blanc
Extra White Flint

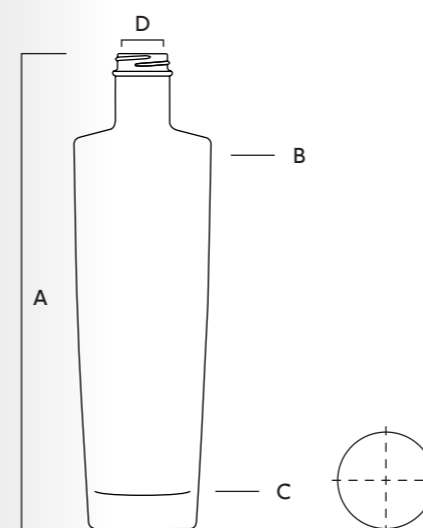







Modèle déposé « Design Saverglass »
Registered "Design Saverglass"



Transgressif, le concept de bouteille THAI s'inspire de l'univers de la Parfumerie et de ses flacons type Eau de Cologne. Deux signes particuliers, le léger cintrage du corps du modèle et la petite semelle de verre plate, concourent à l'élégance subtile de la bouteille. Le bouchage au moyen de capsules préformées type EUROPA ou de capots coiffants constitue un élément de distinction complémentaire. THAI conviendra admirablement à tous types d'usages; spiritueux, eaux, huiles d'olives extra-premium, ...

The THAI bottle is rule breaker. Its design is inspired by the world of fine fragrances and its cologne-style bottles. Two unique features – a slight pinching of body and small flat glass base – add to the bottle's subtle elegance. Another distinct feature of the bottle is its closure that uses EUROPA-style preformed caps or attractive covers. THAI will be beautifully suited to all types of uses: spirits, water, extra virgin olive oil, etc.



Contenance Capacity	20 cl 6.76 oz	37,5 cl 12.68 oz	50 cl 16.91 oz	70 cl 23.67 oz	75 cl 25.36 oz	100 cl 33.82 oz
Référence Reference	3350	3367	3690	3368	3347	3369
Bague Finish	 Europa n°6	 Europa n°6	 Europa n°7	 Europa n°7	 Europa n°7	 Europa n°7
Poids Weight	240 g 8.47 oz	360 g 12.7 oz	480 g 16.93 oz	620 g 21.87 oz	620 g 21.87 oz	785 g 27.69 oz
Hauteur totale [A] Overall height	186 mm 7.32 in	222 mm 8.74 in	247,1 mm 9.73 in	272,4 mm 10.72 in	272,4 mm 10.72 in	287,4 mm 11.31 in
Section maxi [B] Maxi section	49,9 mm 1.96 in	60,4 mm 2.38 in	66 mm 2.6 in	73,6 mm 2.9 in	75,5 mm 2.97 in	84,5 mm 3.33 in
Section mini [C] Mini section	48,6 mm 1.91 in	58,9 mm 2.32 in	64,2 mm 2.53 in	71,6 mm 2.82 in	73,5 mm 2.89 in	82,1 mm 3.23 in
Diamètre de débouchage [D] Entrance bore diameter	11,8 mm 0.46 in	11,8 mm 0.46 in	18,8 mm 0.74 in	18,8 mm 0.74 in	18,8 mm 0.74 in	18,8 mm 0.74 in
Teinte Glass color	○ Extra Blanc Extra White Flint	○ Extra Blanc Extra White Flint	○ Extra Blanc Extra White Flint	○ Extra Blanc Extra White Flint	○ Extra Blanc Extra White Flint	○ Extra Blanc Extra White Flint

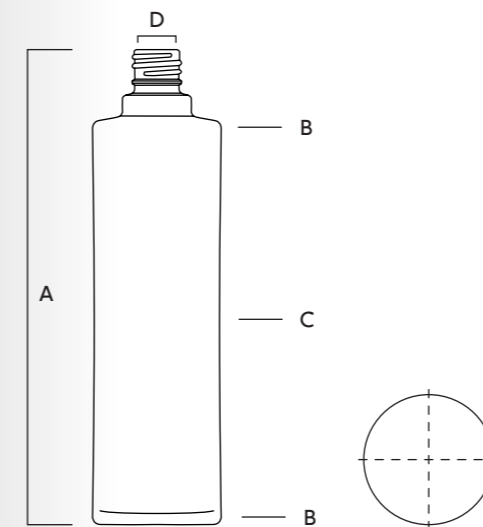



Modèle déposé « Design Saverglass »
Registered "Design Saverglass"



Flacon compact et conique, aux formes légèrement galbées, TSAR rappelle vaguement, les contours inversés, de la papakha russe (ce chapeau de l'armée associé à l'ancien empire russe). TSAR, arbore un profil parfaitement identifiable dans un style épuré où se conjuguent fonctionnalité et ergonomie. Doté d'un col court, ce contenant au design conique inversé, très contemporain, se décline également en 50 cl. Son poids de verre de 620 g seulement lui permet d'être très compétitif.

A compact and tapered bottle featuring slightly rounded shapes, TSAR is faintly reminiscent of the inverted contours featured on the Russian papakha (army hat associated with the former Russian Empire). TSAR sports an immediately recognizable profile with a simple style that combines functionality and ergonomics. Featuring a short neck, this container with an ultra-modern, inverted and tapered design is also available in a 50 cl capacity. Its glass weight of 620 g means it can be very competitive.



Contenance Capacity	50 cl 16.91 oz	70 cl 23.67 oz	75 cl 25.36 oz
Référence Reference	4589	4490	4491
Bague Finish	 Plate	 Plate	 Plate
Poids Weight	491 g 17.32 oz	620 g 21.87 oz	630 g 22.22 oz
Hauteur totale [A] Overall height	210,3 mm 8.28 in	233 mm 9.17 in	233 mm 9.17 in
Section maxi [B] Maxi section	89 × 61,2 mm 3.5 × 2.41 in	99 × 66,7 mm 3.9 × 2.63 in	99 × 70,4 mm 3.9 × 2.77 in
Section mini [C] Mini section	77,7 × 53,4 mm 3.06 × 2.1 in	86,4 × 58 mm 3.4 × 2.28 in	86,4 × 61,9 mm 3.4 × 2.44 in
Diamètre de débouchage [D] Entrance bore diameter	18,5 mm 0.73 in	21,5 mm 0.85 in	21,5 mm 0.85 in
Teinte Glass color	○ Extra Blanc Extra White Flint	○ Extra Blanc Extra White Flint	○ Extra Blanc Extra White Flint

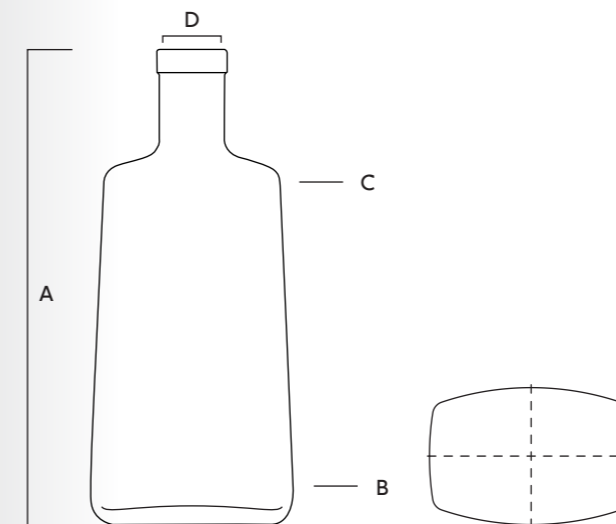

VIRGIN

PREMIUM



Bouteille haute, tout en épure et simplicité, VIRGIN se caractérise par sa forme ronde, son épaule carrée ronde et son poids de verre de seulement 600 g. Sa ligne la classe parmi les intemporelles. Elle saura satisfaire à la fois les marques de spiritueux blancs comme élixirs ambrés. Sa versatilité est mise, tout entière, au service de la personnalisation. Enfin, VIRGIN se décline sous de nombreux formats.

A clean, simple and tall bottle, VIRGIN is characterized by its round shape, rounded square shoulder, and glass weight of only 600 g. Its outline places it among timeless models. It will satisfy the needs of both clear and dark spirit brands, and its versatility means it can be fully customized. Last but not least, VIRGIN is available in several capacities.

VIRGIN

PREMIUM



Contenance Capacity	50 cl 16.91 oz	50 cl 16.91 oz	70 cl 23.67 oz
Référence Reference	5365	5365	4479
Bague Finish	 Plate	 GPI 400/28	 Plate
Poids Weight	435 g 15.34 oz	434 g 15.31 oz	600 g 21.16 oz
Hauteur totale [A] Overall height	264,8 mm 10.43 in	268 mm 10.55 in	315 mm 12.40 in
Section maxi [B] Maxi section	66,8 mm 2.63 in	66,8 mm 2.63 in	71,6 mm 2.82 in
Section mini [C] Mini section	64,4 mm 2.54 in	64,4 mm 2.54 in	68,6 mm 2.7 in
Diamètre de débouchage [D] Entrance bore diameter	18,5 mm 0.73 in	18,5 mm 0.73 in	21,5 mm 0.85 in
Teinte Glass color	○ Extra Blanc Extra White Flint	○ Extra Blanc Extra White Flint	○ Extra Blanc Extra White Flint

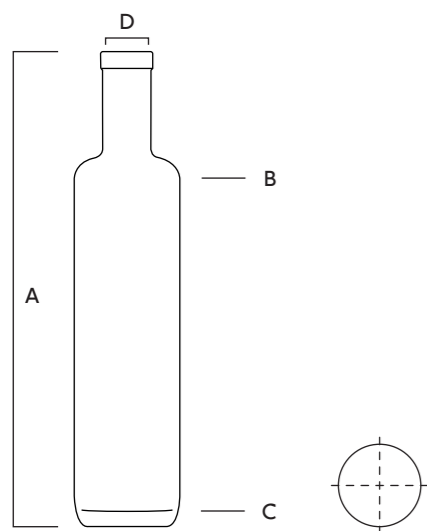

70 cl 23.67 oz	75 cl 25.36 oz	75 cl 25.36 oz	100 cl 33.82 oz	100 cl 33.82 oz
4479	4480	4480	5137	5137
 GPI 400/33	 Plate	 GPI 400/33	 Plate	 GPI 400/33
612 g 21.59 oz	600 g 21.16 oz	612 g 21.59 oz	765 g 26.98 oz	744 g 27.3 oz
316,2 mm 12.45 in	315 mm 12.40 in	316,2 mm 12.45 in	326,9 mm 12.87 in	328,1 mm 12.92 in
71,6 mm 2.82 in	73,6 mm 2.9 in	73,6 mm 2.9 in	83,5 mm 3.29 in	83,5 mm 3.29 in
68,6 mm 2.7 in	70,6 mm 2.78 in	70,6 mm 2.78 in	80,2 mm 3.16 in	80,2 mm 3.16 in
20,7 mm 0.81 in	21,5 mm 0.85 in	20,7 mm 0.81 in	21,5 mm 0.85 in	20,7 mm 0.81 in
○ Extra Blanc Extra White Flint	○ Extra Blanc Extra White Flint	○ Extra Blanc Extra White Flint	○ Extra Blanc Extra White Flint	○ Extra Blanc Extra White Flint

ZADIG

PREMIUM



ZADIG ou ... la destinée d'une bouteille inspirée des anciens flacons d'apothicaires puis récréée avec modernité. Sa forme basse cylindrique trouve son point d'équilibre par le jeu de sa pique conique pointue et de son épaulement, en miroir, la rendant reconnaissable entre toutes. Sa géométrie optimisée lui confère une infinité de possibilités de personnalisation. Et enfin, la profondeur de la gamme est un atout supplémentaire à son utilisation.

ZADIG is what you get when you recreate a bottle inspired by old apothecary bottles with a modern twist. Its cylindrical short profile finds its balance in the interaction between its pointed tapered punt and its shoulder of the same shape, making it stand out from the crowd. Its optimized shape gives it infinite possibilities for customization. And last but not least, its broad range is a plus point in addition to its use.

ZADIG

PREMIUM



Contenance Capacity	5 cl 1.69 oz	5 cl 1.69 oz	20 cl 6.76 oz	20 cl 6.76 oz	37,5 cl 12.68 oz	37,5 cl 12.68 oz
Référence Reference	5829	5829	5720	5720	6040	6040
Bague Finish	 Plate	 BVP 18 STD	 Plate	 GPI 400/28	 Plate	 GPI 400/28
Poids Weight	72 g 2.54 oz	75 g 2.65 oz	220 g 7.76 oz	228 g 8.04 oz	323 g 11.39 oz	328 g 11.57 oz
Hauteur totale [A] Overall height	91 mm 3.58 in	96,6 mm 3.80 in	141,1 mm 5.56 in	145,9 mm 5.74 in	168,9 mm 6.65 in	173,3 mm 6.82 in
Section maxi [B] Maxi section	39,3 mm 1.55 in	39,3 mm 1.55 in	60,4 mm 2.38 in	60,4 mm 2.38 in	72,8 mm 2.87 in	72,8 mm 2.87 in
Diamètre de débouchage [D] Entrance bore diameter	9,5 mm 0.37 in	10,5 mm 0.41 in	17,5 mm 0.69 in	18,5 mm 0.73 in	18,5 mm 0.73 in	18,5 mm 0.73 in
Teinte Glass color	○ Extra Blanc Extra White Flint	○ Extra Blanc Extra White Flint	○ Extra Blanc Extra White Flint	○ Extra Blanc Extra White Flint	○ Extra Blanc Extra White Flint	○ Extra Blanc Extra White Flint

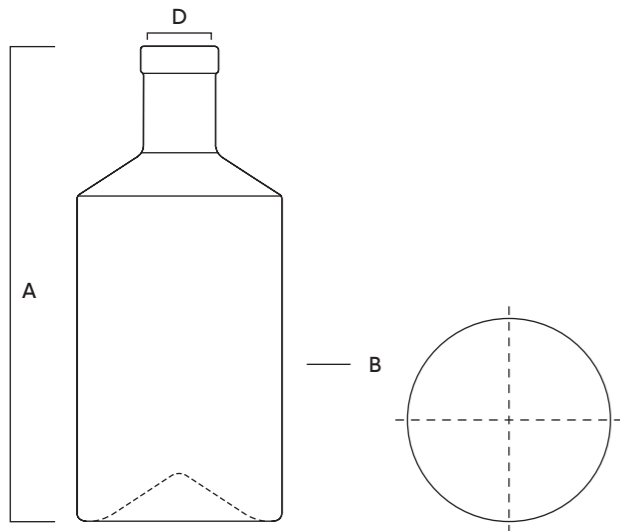

50 cl 16.91 oz	50 cl 16.91 oz	70 cl 23.67 oz	70 cl 23.67 oz	75 cl 25.36 oz	75 cl 25.36 oz	100 cl 33.82 oz	100 cl 33.82 oz
5553	5553	4459	4459	4460	4460	4485	4485
 Plate	 GPI 400/33	 Plate	 GPI 400/33	 Plate	 GPI 400/33	 Plate	 GPI 400/33
441 g 15.56 oz	452 g 15.94 oz	555 g 19.58 oz	570 g 20.11 oz	560 g 19.75 oz	575 g 20.28 oz	680 g 23.99 oz	681 g 24.02 oz
189,6 mm 7.46 in	193,6 mm 7.62 in	210,9 mm 8.30 in	216 mm 8.50 in	210,9 mm 8.30 in	216 mm 8.50 in	246,9 mm 9.72 in	250,9 mm 9.88 in
79,2 mm 3.12 in	79,2 mm 3.12 in	88,3 mm 3.48 in	88,3 mm 3.48 in	91 mm 3.58 in	91 mm 3.58 in	95 mm 3.74 in	95 mm 3.74 in
21,5 mm 0.85 in	21,5 mm 0.85 in	21,5 mm 0.85 in	21,5 mm 0.85 in	21,5 mm 0.85 in	21,5 mm 0.85 in	21,5 mm 0.85 in	21,5 mm 0.85 in
○ Extra Blanc Extra White Flint	○ Extra Blanc Extra White Flint	○ Extra Blanc Extra White Flint	○ Extra Blanc Extra White Flint	○ Extra Blanc Extra White Flint	○ Extra Blanc Extra White Flint	○ Extra Blanc Extra White Flint	○ Extra Blanc Extra White Flint

WINCH

STANDARD PREMIUM



230 | 231



WINCH est une bouteille à la personnalité bien marquée : une silhouette « médium » (hauteur corps intermédiaire), une épaule très arrondie favorisée par un diamètre corps généreux, et une semelle de verre de 10 mm d'épaisseur définissent les contours. Puis, de manière à lever toute ambiguïté, et ancrer ce bel écrin dans des codes de reconnaissance du Whisky, ont été ajoutés : un bas-col avec un renflement marqué (le mollet), des bouchages extra-hauts (bagues Bouchon ou à vis).

WINCH is a bottle with a distinct personality, featuring a medium silhouette (intermediate body height), a well-rounded shoulder accentuated by a generous body diameter, and a 10 mm thick glass base that outlines the contours. The following features were added on top to root this beautiful container in recognizable whiskey codes and make its inspiration crystal clear: a short neck with a pronounced swelling (bulb) and extra-high closures (cork or screw finish).



Contenance Capacity	70 cl 23.67 oz	75 cl 25.36 oz
Référence Reference	T296	3819
Bague Finish	 Plate SB 26	 Plate SB 26
Poids Weight	730 g 25.75 oz	730 g 25.75 oz
Hauteur totale [A] Overall height	218 mm 8.58 in	218 mm 8.58 in
Section maxi [B] Maxi section	97,5 mm 3.84 in	100,2 mm 3.94 in
Section mini [C] Mini section	96,5 mm 3.8 in	99,2 mm 3.91 in
Diamètre de débouchage [D] Entrance bore diameter	18,5 mm 0.73 in	18,5 mm 0.73 in
Teinte Glass color	○ Extra Blanc Extra White Flint	○ Extra Blanc Extra White Flint

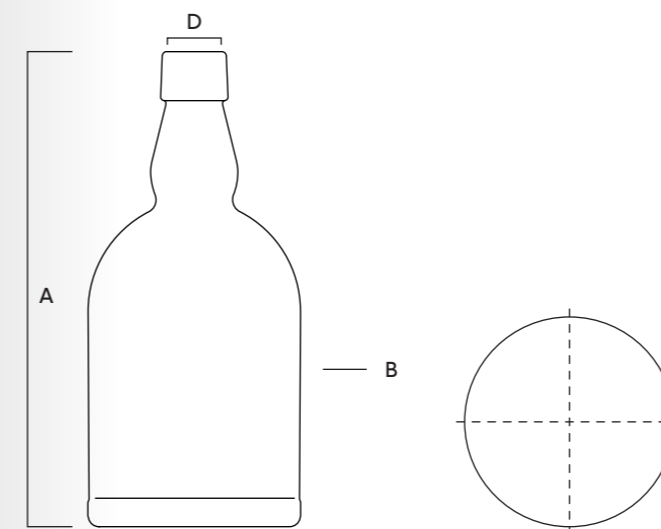

Modèle déposé « Design Saverglass »
Registered "Design Saverglass"

BAMBOO

STANDARD PREMIUM



232 | 233



Héritière de la ligne Bellissima, cette version, plus sobre, livre ses plus beaux atours pour séduire. Tout d'abord, BAMBOO interpelle par sa silhouette spectaculaire! Gracile et fuselée, cette forme «extra-haute» est dotée d'un col long qui contribue à son bel équilibre et facilite sa préhension. Son esthétique tout en délicatesse viendra sublimer avec raffinement et élégance tous les types de spiritueux. BAMBOO présente une belle profondeur de gamme.

Heir to the BELLISSIMA line, this simpler version reveals the finest features to make it charming. BAMBOO immediately turns heads with its spectacular silhouette! Sleek and slender, this extra tall bottle features a long neck that adds to its fine balance and makes it easier to hold. Its delicate esthetics will enhance all types of spirits with sophistication and elegance. BAMBOO features a comprehensive range.



Contenance Capacity	37,5 cl 12.68 oz	50 cl 16.91 oz	70 cl 23.67 oz	75 cl 25.36 oz	100 cl 33.82 oz
Référence Reference	3364	4486	3652	2425	3151
Bague Finish	 Plate	 Plate	 Plate	 Plate	 Plate
Poids Weight	352 g 12.42 oz	456 g 16.08 oz	595 g 20.99 oz	620 g 21.87 oz	732 g 25.82 oz
Hauteur totale [A] Overall height	276,9 mm 10.90 in	302 mm 11.89 in	338,6 mm 13.33 in	341,5 mm 13.44 in	373,6 mm 14.71 in
Section maxi [B] Maxi section	58,1 mm 2.29 in	64,1 mm 2.52 in	70,5 mm 2.78 in	72,6 mm 2.86 in	79,2 mm 3.12 in
Diamètre de débouchage [D] Entrance bore diameter	17,5 mm 0.69 in	17,5 mm 0.69 in	18,5 mm 0.73 in	18,5 mm 0.73 in	20,5 mm 0.81 in
Teinte Glass color	○ Extra Blanc Extra White Flint	○ Extra Blanc Extra White Flint	○ Extra Blanc Extra White Flint	○ Extra Blanc Extra White Flint	○ Extra Blanc Extra White Flint

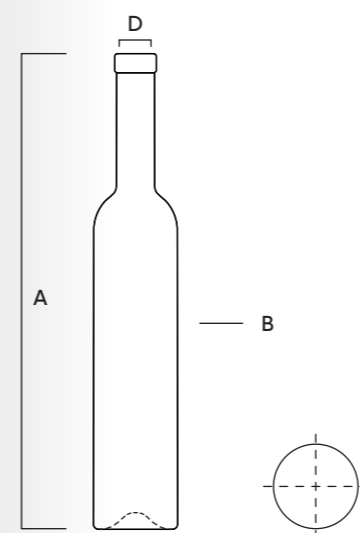

Modèle déposé « Design Saverglass »
Registered "Design Saverglass"

BASQUAISE

STANDARD PREMIUM



Historiquement conçues pour servir la noble cause de l'appellation « ARMAGNAC », les BASQUAISES savent s'ouvrir à de nombreux autres usages et conviennent à tous les types d'alcools. Le modèle BASQUAISE a pour avantage d'offrir des facings imposants laissant libre cours à de multiples combinaisons de personnalisation. Rarement une gamme, dite « classique », n'aura été aussi complète en termes de contenances.

Historically designed to serve the noble cause of the "ARMAGNAC" name, BASQUAISE bottles can be opened to up to many other uses and are suitable for all types of alcohol. The BASQUAISE model has the advantage of offering impressive label panels, giving free rein for a multitude of customization combinations. Rarely will the capacities of a "classic" range be as comprehensive as this one.

BASQUAISE

STANDARD PREMIUM



Contenance Capacity	5 cl 1.69 oz	35 cl 11.84 oz	50 cl 16.91 oz
Référence Reference	895	1773	1956
Bague Finish	 PP 18	 Plate Bouchon à tête 29	 Plate Bouchon à tête 29
Poids Weight	88 g 3.1 oz	350 g 12.35 oz	485 g 17.11 oz
Hauteur totale [A] Overall height	100,4 mm 3.95 in	170 mm 6.69 in	202 mm 7.95 in
Section maxi [B] Maxi section	65,5 × 30 mm 2.58 × 1.18 in	118,5 × 60 mm 4.67 × 2.36 in	136,3 × 60 mm 5.37 × 2.36 in
Diamètre de débouchage [D] Entrance bore diameter	10,5 mm 0.41 in	18,5 mm 0.73 in	18,5 mm 0.73 in

Teinte Glass color	○ Extra Blanc Extra White Flint	○ Extra Blanc Extra White Flint	● Champagne Champagne Green
	● Champagne Champagne Green	● Champagne Champagne Green	

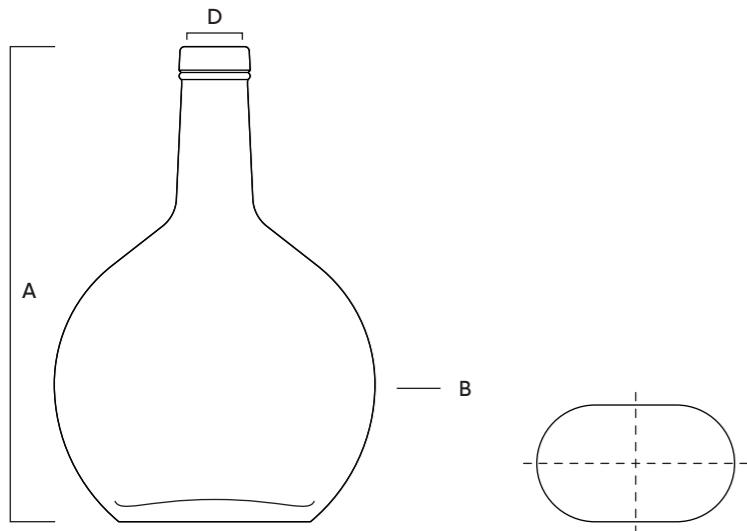

70 cl 23.67 oz	70 cl 23.67 oz	75 cl 25.36 oz	100 cl 33.82 oz	150 cl 50.72 oz
1854	1854	1257	1789	1256
 BVP 31 H 60 SP	 Plate Bouchon à tête 29	 Plate Bouchon à tête 29	 Plate Bouchon à tête 29	 Plate Bouchon à tête 29
590 g 20.81 oz	580 g 20.46 oz	650 g 22.93 oz	850 g 29.98 oz	1050 g 37.04 oz
226,9 mm 8.93 in	219,5 mm 8.64 in	219 mm 8.62 in	242 mm 9.53 in	258 mm 10.16 in
150 × 65 mm 5.91 × 2.56 in	150 × 65 mm 5.91 × 2.56 in	151 × 71,3 mm 5.94 × 2.81 in	167,8 × 74,9 mm 6.61 × 2.95 in	179 × 102,5 mm 7.05 × 4.04 in
19 mm 0.75 in	18,5 mm 0.73 in	18,5 mm 0.73 in	18,5 mm 0.73 in	18,5 mm 0.73 in
○ Extra Blanc Extra White Flint	○ Extra Blanc Extra White Flint	○ Extra Blanc Extra White Flint	○ Extra Blanc Extra White Flint	○ Extra Blanc Extra White Flint
● Champagne Champagne Green	● Champagne Champagne Green	● Champagne Champagne Green	● Champagne Champagne Green	● Champagne Champagne Green
		● Jaune Foncé Dark Amber		

CALVADOS & NORMANDE HAUTE

STANDARD PREMIUM



Aisément reconnaissables par leurs formes profondément authentiques, les bouteilles de la gamme CALVADOS & NORMANDIE HAUTE sont parfaitement adaptées au marché de proximité des alcools dérivés de la pomme, mais peuvent sans conteste servir d'autres alcools. Disponibles en différentes contenances ainsi que dans les teintes de verre extra-blanc et antique, elles présentent une belle modularité et s'ouvrent ainsi à de multiples usages.

Easily recognizable from their thoroughly authentic shapes, bottles in the CALVADOS & NORMANDIE HAUTE range are perfectly suited to the regional market for apple-based spirits, but they can, of course, serve other alcohols too. Available in various capacities as well as in extra-white and antique glass tints, these bottles are very versatile and are open to multiple uses.



CALVADOS



CALVADOS



CALVADOS

Contenance Capacity	35 cl 11.84 oz	50 cl 16.91 oz	50 cl 16.91 oz
Référence Reference	T174	T832	T832
Bague Finish	 Plate Bouchon à tête 28	 Plate Bouchon à tête 28	 BVP 31 Haute
Poids Weight	360 g 12.7 oz	395 g 13.93 oz	410 g 14.46 oz
Hauteur totale [A] Overall height	217,5 mm 8.56 in	248 mm 9.76 in	255,4 mm 10.06 in
Section maxi [B] Maxi section	71 mm 2.8 in	76,4 mm 3.01 in	76,4 mm 3.01 in
Section mini [C] Mini section	65,4 mm 2.57 in	70,4 mm 2.77 in	70,4 mm 2.77 in
Diamètre de débouchage [D] Entrance bore diameter	18,5 mm 0.73 in	18,5 mm 0.73 in	19 mm 0.75 in

Teinte Glass color	○ Extra Blanc Extra White Flint	● Jaune Foncé Dark Amber	○ Extra Blanc Extra White Flint
	● Jaune Foncé Dark Amber	● Jaune Foncé Dark Amber	● Jaune Foncé Dark Amber

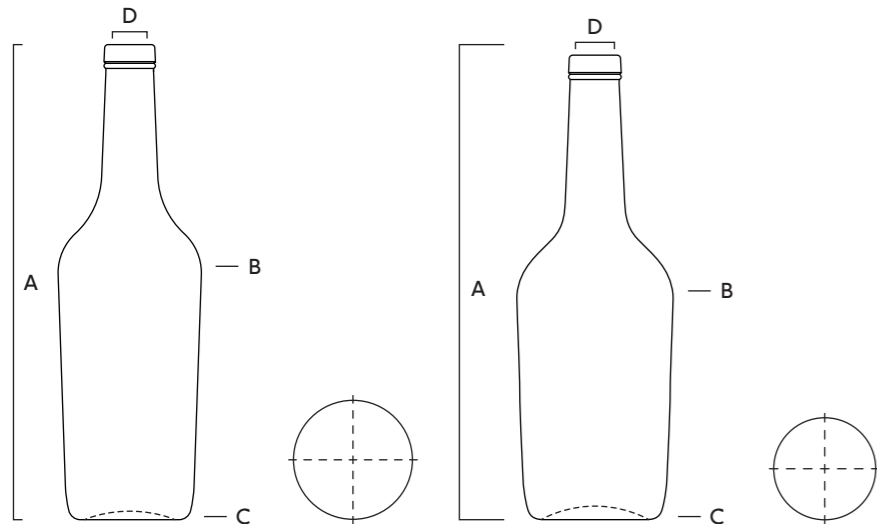

CALVADOS



CALVADOS



CALVADOS



NORMANDE HAUTE

70 cl 23.67 oz	70 cl 23.67 oz	75 cl 25.36 oz	75 cl 25.36 oz
T722	T722	T157	1963
 BVP 31,5 H 60	 Plate Bouchon à tête 28	 Plate Bouchon à tête 29	 Plate Bouchon à tête 29
490 g 17.28 oz	490 g 17.28 oz	485 g 17.11 oz	520 g 18.34 oz
286,4 mm 11.28 in	279 mm 10.98 in	279 mm 10.98 in	272,5 mm 10.73 in
84,2 mm 3.31 in	84,2 mm 3.31 in	84,3 mm 3.32 in	90,2 mm 3.55 in
76 mm 2.99 in	76 mm 2.99 in	80,3 mm 3.16 in	82,8 mm 3.26 in
19 mm 0.75 in	18,5 mm 0.73 in	18,5 mm 0.73 in	18,5 mm 0.73 in

● Jaune Foncé Dark Amber	● Jaune Foncé Dark Amber	○ Extra Blanc Extra White Flint	○ Extra Blanc Extra White Flint
● Jaune Foncé Dark Amber	● Jaune Foncé Dark Amber	● Jaune Foncé Dark Amber	● Jaune Foncé Dark Amber

LES CHARENTAISES

STANDARD PREMIUM



Empreinte d'un sens inné de la sobriété et de la tradition, la gamme des CHARENTAISES (CHARENTAISE, COGNACAISE, PAILLARDE) regroupe des formes rondes génériques, ergonomiques et fonctionnelles, au style authentique.

Imbued with an innate sense of simplicity and tradition, the CHARENTAISE range (CHARENTAISE, COGNACAISE and PAILLARDE) brings together standard, ergonomic and functional round shapes with an authentic style.

	CHARENTAISE	CHARENTAISE	CHARENTAISE	COGNAÇAISE	COGNAÇAISE	COGNAÇAISE
Contenance Capacity	3 cl 1.01 oz	5 cl 1.69 oz	116 cl 39.23 oz	20 cl 6.76 oz	35 cl 11.84 oz	50 cl 16.91 oz
Référence Reference	1471	1352	1362	1610	2316	2460
Bague Finish	 PP 18	 PP 18	 Plate Bouchon à tête 29	 Plate Bouchon à tête 25	 Plate Bouchon à tête 29	 Plate Bouchon à tête 29
Poids Weight	60 g 2.12 oz	83 g 2.93 oz	695 g 24.51 oz	243 g 8.57 oz	390 g 13.76 oz	420 g 14.81 oz
Hauteur totale [A] Overall height	111 mm 4.37 in	125 mm 4.92 in	318 mm 12.52 in	205 mm 8.07 in	244,2 mm 9.61 in	268,4 mm 10.57 in
Section maxi [B] Maxi section	29,8 mm 1.17 in	34,8 mm 1.37 in	89 mm 3.5 in	51,3 mm 2.02 in	60,6 mm 2.39 in	66,9 mm 2.63 in
Section mini [C] Mini section	- -	- -	87,6 mm 3.45 in	- -	- -	- -
Diamètre de débouchage [D] Entrance bore diameter	10,5 mm 0.41 in	10,5 mm 0.41 in	18,5 mm 0.73 in	15,5 mm 0.61 in	18,5 mm 0.73 in	18,5 mm 0.73 in
Teinte Glass color	○ Extra Blanc Extra White Flint	○ Extra Blanc Extra White Flint	○ Extra Blanc Extra White Flint	○ Extra Blanc Extra White Flint	○ Extra Blanc Extra White Flint	○ Extra Blanc Extra White Flint

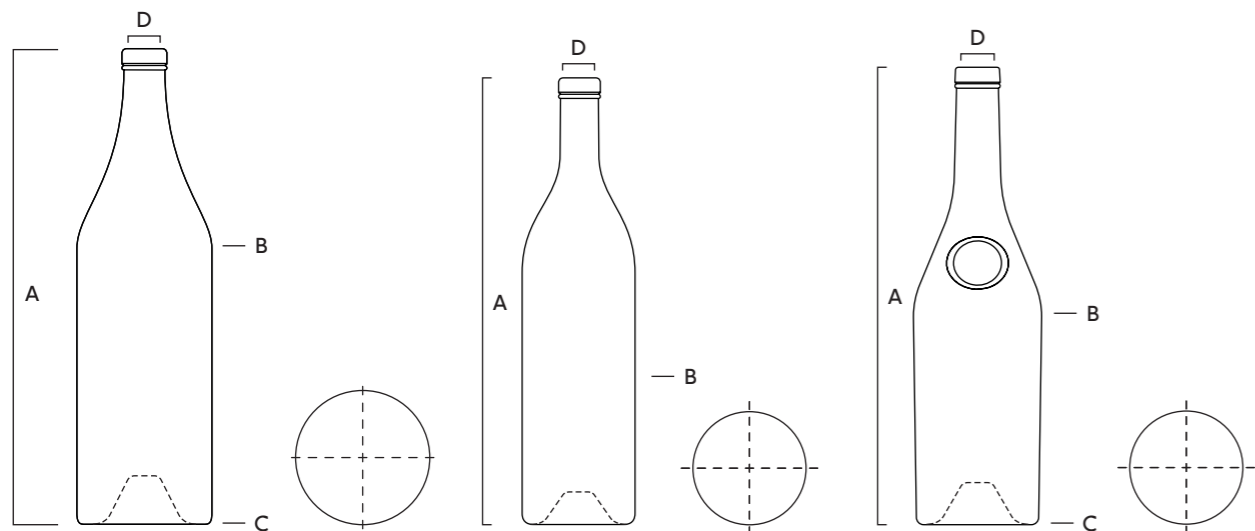

244 | 245

COGNAÇAISE	COGNAÇAISE	COGNAÇAISE	COGNAÇAISE	COGNAÇAISE	PAILLARDE	PAILLARDE
70 cl 23.67 oz	70 cl 23.67 oz	75 cl 25.36 oz	100 cl 33.82 oz	150 cl 50.72 oz	70 cl 23.67 oz	75 cl 25.36 oz
1856	1856	1968	3654	1247	1857	1969
 Plate Bouchon à tête 29	 BVP 31.5 H 60	 Plate Bouchon à tête 29	 Plate Bouchon à tête 29	 Plate Bouchon à tête 29	 Plate Bouchon à tête 29	 Plate Bouchon à tête 29
533 g 18.8 oz	550 g 19.4 oz	530 g 18.69 oz	760 g 26.81 oz	1074 g 37.88 oz	650 g 22.93 oz	650 g 22.93 oz
299 mm 11.77 in	307 mm 12.09 in	299 mm 11.77 in	337 mm 13.27 in	335,3 mm 13.20 in	305,5 mm 12.03 in	305,5 mm 12.03 in
74,2 mm 2.92 in	74,2 mm 2.92 in	76,2 mm 3 in	84,5 mm 3.33 in	106,2 mm 4.18 in	83 mm 3.27 in	85,6 mm 3.37 in
- -	- -	- -	- -	- -	79 mm 3.11 in	81,6 mm 3.21 in
18,5 mm 0.73 in	19 mm 0.67 in	18,5 mm 0.73 in	18,5 mm 0.73 in	21,5 mm 0.76 in	18,5 mm 0.73 in	18,5 mm 0.73 in
○ Extra Blanc Extra White Flint	○ Extra Blanc Extra White Flint	○ Extra Blanc Extra White Flint	○ Extra Blanc Extra White Flint	○ Extra Blanc Extra White Flint	○ Extra Blanc Extra White Flint	○ Extra Blanc Extra White Flint

MARTINIQUE

STANDARD PREMIUM

246 | 247



Le col à mollet, l'épaule et le « diamètre corps » généreux, associés à une piqûre imposante, font du modèle MARTINIQUE l'une des valeurs sûres des gammes traditionnelles de Saverglass et rendent difficile la dissimulation de leur inclination pour les rhums vieux. Cette gamme caractéristique saura convenir à d'autres catégories de spiritueux en recherche d'authenticité ou souhaitant travailler le détournement.

An impressive punt combined with a generous shoulder, ample body diameter, and a neck featuring a bulb, all make the MARTINIQUE model one of the guaranteed successes in traditional Saverglass ranges and makes no bones about its inclination toward vintage rums. This distinctive range will be suitable for other categories of spirits that seek authenticity or wish to try recreating the codes of other spirits.



Contenance
Capacity

70 cl
23.67 oz

75 cl
25.36 oz

Référence
Reference

202

1976

Bague
Finish



Poids
Weight

685 g
24.16 oz

600 g
21.16 oz

Hauteur
totale [A]
Overall
height

234,5 mm
9.23 in

234,5 mm
9.23 in

Section
maxi [B]
Maxi
section

95,4 mm
3.76 in

95,4 mm
3.76 in

Section
mini [C]
Mini
section

93 mm
3.66 in

93 mm
3.66 in

Diamètre de
débouchage
[D] Entrance
bore diameter

18,5 mm
0.73 in

18,5 mm
0.73 in

Teinte
Glass color

○ Extra Blanc
Extra White Flint

● Jaune Foncé
Dark Amber

○ Extra Blanc
Extra White Flint

● Jaune Foncé
Dark Amber

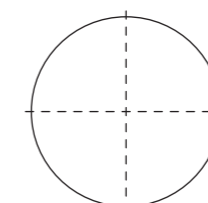
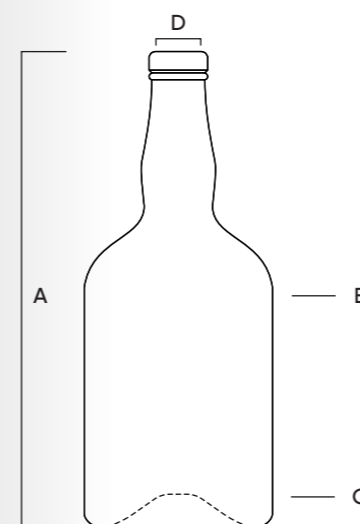

FLÛTE DISTILLATEUR

STANDARD PREMIUM



La gamme de flûtes DISTILLATEURS s'étend de la miniature 3 cl au format 300 cl, et propose le format bouteille 70 cl dans sa version bouchon liège à tête, uniquement. Ce « classique » du marché, intègre tous les éléments distinctifs liés à la qualité Saverglass, à savoir: la sobriété et l'efficacité du design, l'utilisation du verre « extra-blanc » et la qualité des productions qui ont fait la réputation de Saverglass.

The DISTILLATEUR flute range extends from the 3 cl miniature to a capacity of 300 cl and offers a 70 cl bottle capacity exclusively for its capped cork version. This market classic includes all the distinctive hallmarks of Saverglass quality: simple and efficient design, use of "extra-white" glass, and high-quality creations that have given Saverglass its excellent reputation.

FLÛTE DISTILLATEUR

STANDARD PREMIUM



Contenance Capacity	3 cl 1.01 oz	35 cl 11.84 oz	50 cl 16.91 oz
Référence Reference	1177	911	1238
Bague Finish	 BVP 18 STD	 BVP 30 H 60	 BVP 30 H 60
Poids Weight	60 g 2.12 oz	440 g 15.52 oz	420 g 14.81 oz
Hauteur totale [A] Overall height	117,5 mm 4.63 in	290 mm 11.42 in	318,3 mm 12.53 in
Section maxi [B] Maxi section	30,5 mm 1.2 in	59,6 mm 2.35 in	66,2 mm 2.61 in
Diamètre de débouchage [D] Entrance bore diameter	10,5 mm 0.41 in	19 mm 0.75 in	19 mm 0.75 in
Teinte Glass color	○ Extra Blanc Extra White Flint	○ Extra Blanc Extra White Flint	○ Extra Blanc Extra White Flint

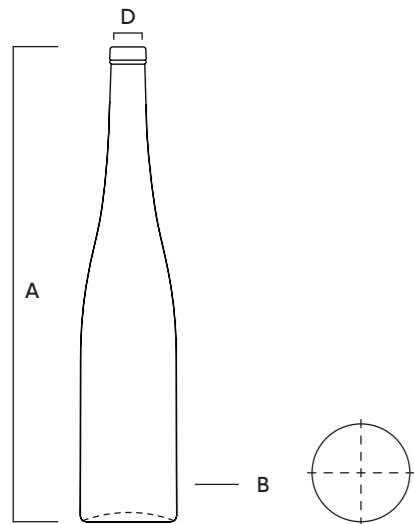

70 cl 23.67 oz	75 cl 25.36 oz	150 cl 50.72 oz	300 cl 101.45 oz
0471	0928	0719	2665
 Plate Bouchon à tête 27	 BVP 30 H 60	 Plate	 Plate
540 g 19.05 oz	550 g 19.4 oz	1230 g 43.39 oz	1700 g 59.96 oz
342,5 mm 13.48 in	350 mm 13.78 in	478 mm 18.82 in	521,3 mm 20.52 in
74,5 mm 2.93 in	75,8 mm 2.98 in	93,5 mm 3.68 in	121 mm 4.76 in
17,5 mm 0.69 in	20 mm 0.79 in	18,5 mm 0.73 in	24 mm 0.94 in
○ Extra Blanc Extra White Flint	○ Extra Blanc Extra White Flint	○ Extra Blanc Extra White Flint	○ Extra Blanc Extra White Flint

LES MINIATURES

STANDARD PREMIUM



Composée de divers modèles de MINIATURES aux formes génériques ou régionales, cette gamme s'inscrit dans l'expertise de Saverglass pour ce type de format. Par ailleurs, cet assortiment s'étend à d'autres lignes de bouteilles et propose des modèles plus originaux et distinctifs, qu'il est aisé de retrouver dans d'autres gammes de bouteilles de la collection.

Comprising various MINIATURES models in standard or regional shapes, this range forms part of the Saverglass expertise for this type of capacity. This collection also extends to other bottle lines and offers more original and distinctive models as clearly demonstrated in the collection's other ranges.



WHISKY STANDARD



ANGLAISE



MARIE-LAURENCE

Contenance Capacity	5 cl 1.69 oz	5 cl 1.69 oz	5 cl 1.69 oz
Référence Reference	1862	0709	0917
Bague Finish	 PP20	 PP18	 PP20
Poids Weight	79 g 2.79 oz	87 g 3.07 oz	60 g 2.12 oz
Hauteur totale [A] Overall height	116,4 mm 4.58 in	120,5 mm 4.74 in	93,6 mm 3.69 in
Section maxi [B] Maxi section	35,8 mm 1.41 in	36,3 mm 1.43 in	40,8 mm 1.61 in
Section mini [C] Mini section	- -	- -	40,3 mm 1.59 in
Diamètre de débouchage [D] Entrance bore diameter	12 mm 0.47 in	10,5 mm 0.41 in	12 mm 0.47 in

Teinte
Glass color

○ Extra Blanc
Extra White Flint

○ Extra Blanc
Extra White Flint

● Champagne
Champagne Green

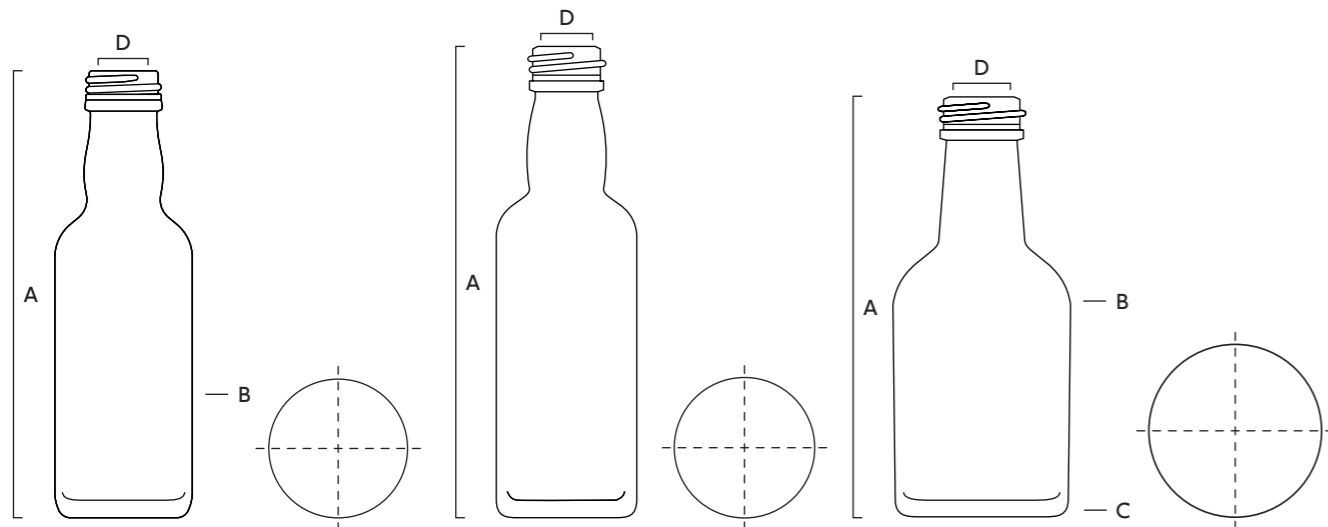

254 | 255



COGNAC



COGNAC



NATHALIE



NATHALIE

3 cl 1.01 oz	5 cl 1.69 oz	3 cl 1.01 oz	5 cl 1.69 oz
1023	1088	0466	0799
 PP18	 BVP18 STD	 PP18 STD	 PP18 STD
55 g 1.94 oz	65 g 2.29 oz	60 g 2.12 oz	70 g 2.47 oz
90,4 mm 3.56 in	100 mm 3.94 in	100,9 mm 3.97 in	112 mm 4.41 in
37,5 mm 1.48 in	42,5 mm 1.67 in	34,2 mm 1.35 in	39 mm 1.54 in
36,5 mm 1.44 in	41,5 mm 1.63 in	- -	- -
10,5 mm 0.41 in	10,5 mm 0.41 in	10,5 mm 0.41 in	10,5 mm 0.41 in

○ Extra Blanc
Extra White Flint

○ Extra Blanc
Extra White Flint

○ Extra Blanc
Extra White Flint

○ Extra Blanc
Extra White Flint

● Champagne
Champagne Green

○ Extra Blanc
Extra White Flint

● Champagne
Champagne Green

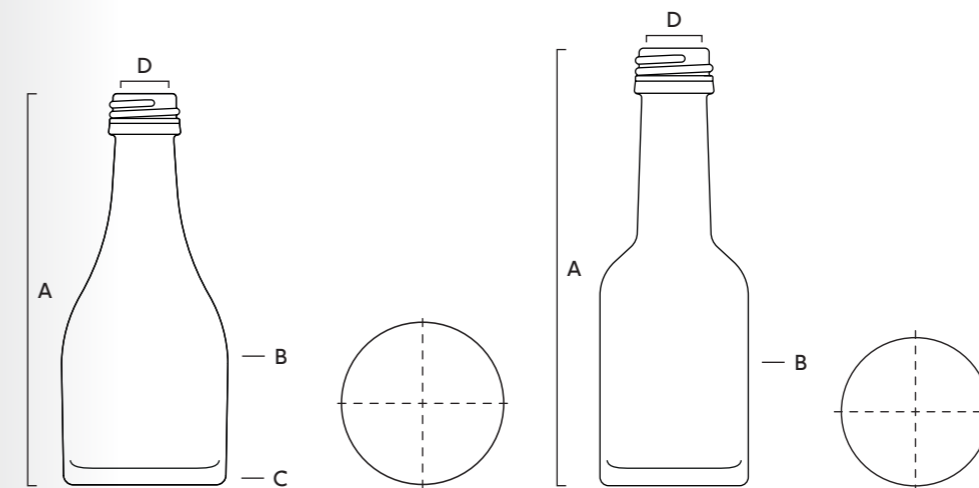

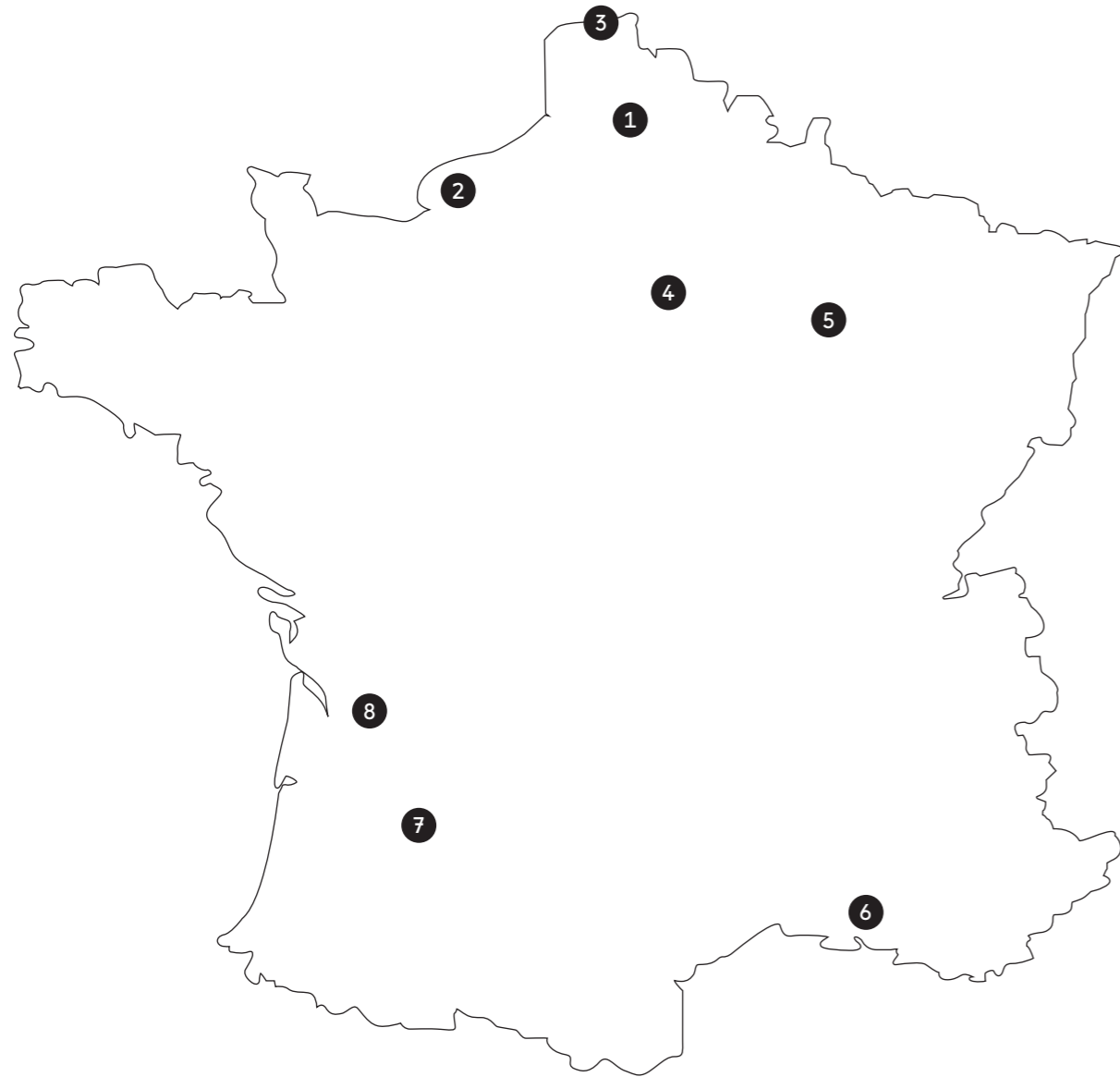

1 SAVERGLASS

France - Feuquières
 Siège Social et Usine verre et décor
 Headquarter and glass and decoration factory
 ▼▲■
 3, Place de la Gare
 60960 Feuquières
 T +33 (0)3 44 46 45 45

3 ALPHAGLASS – ALPHADEC

France - Arques
 ▼▲
 Zone Industrielle du Hocquet
 62510 Arques
 T +33 (0)3 21 11 50 50

5 SAVERGLASS CHAMPAGNE

France - Pierry
 ●
 Pôle d'activités Saint Julien
 Allée Maxenu
 51530 Pierry
 T +33 (0)3 26 58 17 85

7 V.D.A. Verreries et Décors d'Armagnac

France - Condom
 ●
 Route de Nérac -Z.I. de Pôme
 32100 Condom
 T +33 (0)5 62 68 30 10

2 TOURRES & CIE

France - Le Havre
 ▼
 111, rue de la Vallée
 CS 95010
 76071 Le Havre Cedex
 T +33 (0)2 35 55 28 28

4 SAVERPLUS

France - Coulommiers
 ▲
 9, 11 rue de l'Aubetin
 77120 Coulommiers
 T +33 (0)1 64 75 82 82

6 SAVERSUD

France - Venelles
 ●
 VenelTech - Bat. A2
 994 rue de la Gare
 13770 Venelles
 T +33 (0)4 42 90 40 17

8 SAVERGLASS COGNAC

France - Cognac
 ■●
 Z.I. de Merpins
 rue Jacques Marzio
 16100 Merpins
 T +33 (0)5 45 82 35 79

CONTACTEZ-NOUS
www.saverglass.com

▼ Usines verre
 Glass factories

▲ Usines décor
 Decoration factories

● Filiales et Bureaux
 Subsidiaries and Offices

■ Showrooms
 Showrooms



EUROPE EUROPA

1 SAVERGLASS IBERICA

Portugal – Sintra
Portugal – Sintra
● ●
Avenida Almirante
Gago Coutinho, 132 - 134, Edifício 2
2710-418 Sintra – Portugal
T +351 21 924 80 60 / 61 / 62

2 SAVERGLASS IBERICA

Espagne – Madrid
Spain – Madrid
■ ●
Plaza Carlos Trías Bertrán, 4
1ª Planta
Ibercenter Business Center
28020 Madrid – Spain
T +(34) 91 418 45 09

3 SAVERGLASS ITALIA

Italie – Milan
Italy – Milan
■ ●
Via Lazzaretto, 19
20124 Milano – Italia
T +(39) 024 549 0078

4 SAVERGLASS RUSSIA

Russie – Moscou
Russia – Moscow
●
Zubovski proezd 2
Build. 1, office 3.
Moscow, 119021 – Russia
T +7 (495) 780 0580

5 SAVERGLASS UK

Royaume-Uni
United Kingdom
●
Angleterre & Pays de Galles
England & Wales
T +44 (0) 7703 184200
—
Écosse & Irlande
Scotland & Ireland
T +44 (0) 7538 651337

AMÉRIQUE DU NORD NORTH AMERICA

6 SAVERGLASS USA

États-Unis – Californie
U.S.A. – California
■ ●
841 Latour Court
Suite B
Napa CA 94558 – USA
T +1 (707) 259 2930

7 SAVERGLASS USA

États-Unis – Kentucky
U.S.A. – Kentucky
■ ●
607 W Main St.
Suite 401
Louisville KY 40202 – USA
T +1 502 365 2333

8 SAVERGLASS USA

États-Unis – New Jersey
U.S.A. – New Jersey
●
107 Spring Street
Suite 210
Ramsey NJ 07446 – USA
T +1 (201) 825 7100

9 SAVERGLASS MEXICO

Mexique - Acatlan de Juarez
Mexico - Acatlan de Juarez
▼ ▲
Carretera Libre Acatlan de Juarez
a Cd. Guzman Km 11
Centro Logistico Jalisco
Area Industrial
45713 Acatlan de Juarez, Jalisco
Mexico

10 SAVERGLASS MEXICO

Mexique - Guadalajara
Mexico - Guadalajara
●
Torre Ganesh
Ahuizotl #2276, Cd del Sol
45050 Zapopan
Guadalajara, Jalisco – Mexico
T +(52) 1 33 3884 0900

AUSTRALIE AUSTRALIA

11 SAVERGLASS AUSTRALIA

Australie – Adelaide
Australia – Adelaide
■ ●
289 Flinders Street,
PO Box 6537 (Halifax street)
Adelaide SA 5000 – Australia
T +61 (08) 8232 0770

12 SAVERGLASS AUSTRALIA

Australie – Melbourne
Australia – Melbourne
■ ●
Level 2, 7 River Street,
South Yarra, Victoria 3142
Melbourne – Australia
T +61 (39) 4138 1300

13 SAVERGLASS NEW ZEALAND

Nouvelle Zélande – Auckland
New Zealand – Auckland
●
PO Box
Symonds St
Auckland 1150 – New Zealand
T +64 9 522 2990

AFRIQUE MOYEN-ORIENT AFRICA MIDDLE EAST

14 SAVERGLASS SOUTH AFRICA

Afrique du Sud – Somerset West
South Africa – Somerset West
●
P.O. Box 333
Somerset Mall, 7137 – South Africa
T +27 (021) 851 0005

15 SAVERGLASS UNITED ARAB EMIRATES

E.A.U. – Ras al Khaimah
U.A.E. – Ras al Khaimah
▼
Al Jazeera - Al Hamra
PO Box 86333
Ras al Khaimah
United Arab Emirates
T +971 7 203 4800

CONTACT US

www.saverglass.com

▼ Usines verre
Glass factories

▲ Usines décor
Decoration factories

● Filiales et Bureaux
Subsidiaries and Offices

■ Showrooms
Showrooms

SAVERGLASS IN THE WORLD

SAVERGLASS DANS LE MONDE

SAVERGLASS se réserve le droit de modifier ou de supprimer certains modèles figurant dans les gammes présentées, ou de supprimer certaines versions de contenance, de teinte ou de bouchage. Les éléments techniques dans ce catalogue, et notamment les caractéristiques dimensionnelles des articles, n'ont qu'un caractère indicatif. Ils ne peuvent être utilisés en l'état pour la vérification de compatibilité sur lignes d'embouteillage, problème de machinabilité ou pour l'étude de processus d'habillage (étiquetage, bouchage, capsulage, parachèvement, ...) et de compatibilité de sur-emballage. Pour ce faire, SAVERGLASS recommande l'utilisation de ses plans verriers en vigueur et d'échantillons verre disponibles sur simple demande.

SAVERGLASS est titulaire de tous les droits de propriété intellectuelle (brevets, droit d'auteur, dessin, modèle, marque et autres) afférents, relatifs et/ou attachés aux modèles dits « Design Saverglass » et aux modèles personnalisés ou déclinés des modèles « Design Saverglass », ainsi qu'aux articles représentant ou reproduisant ces modèles, ce que reconnaît le Client qui s'interdit de se prévaloir ou de revendiquer un quelconque droit de propriété de la nature de ceux précités sur lesdits modèles, comme de les reproduire ou les représenter ou les faire reproduire ou représenter par un tiers, notamment sous forme de cols verriers quels que soit leur usage et leur destination. SAVERGLASS est également titulaire de tous droits de propriété sur tous les plans verriers, plans projets, plans 3D, dessins, modèles, maquettes, échantillons, typons, ébauches, croquis, projets, études, moules et autres documents techniques ou artistiques de toute nature qui émanent de sa part et peuvent, dans leurs rapports commerciaux, et à la discrétion de SAVERGLASS, être adressés au Client. Le Client s'interdit expressément de divulguer ceux-ci comme d'en faire un quelconque usage autre que dans le cadre de ses seuls rapports commerciaux avec SAVERGLASS.

SAVERGLASS reserves the right to modify or delete any of the designs shown, and to delete any sizes, colours or corking versions. The technical features stated in this catalogue, and in particular the dimensions of the items, are intended only as a guide. They cannot be used "as-stated" for checking compatibility on bottling lines, for checking machining problems, or to assess the decorating process (labelling, corking, capping, finishing, etc.) or the compatibility of primary or second packaging. SAVERGLASS recommends using the glass drawings and samples available by simple request for this purpose.

SAVERGLASS is the holder of all intellectual property rights (patents, copyrights, drawings, designs, trademarks and others) pertaining to, relating to and/or associated with "Design Saverglass" designs and with customised or adjusted "Design Saverglass" designs, as well as with all items representing or copying those designs, the Client acknowledging the foregoing and agreeing to refrain from using or challenging any of the aforesaid intellectual property rights to said designs, including reproducing these or having these reproduced by a third party, particularly in the form of a bottleneck, regardless of its use or purpose. SAVERGLASS is also the holder of all ownership rights to all glasswork plans, project plans, 3D plans, drawings, templates, mock-ups, samples, artwork, drafts, sketches, projects, studies, moulds, and other technical or artistic documents of any kind issued by it and that may, in business relationships and at the discretion of SAVERGLASS, be enforceable against the Client. The Client expressly undertakes to refrain from disclosing any of the above as well as from any usage that does not fall within the scope of its business relationships with SAVERGLASS.