

DA DUOMO®

estal

www.estal.com
+34 972 821 676

Modelo registrado/
Registered model/
Modèle enregistré



FEA 15



EXTRA FLINT

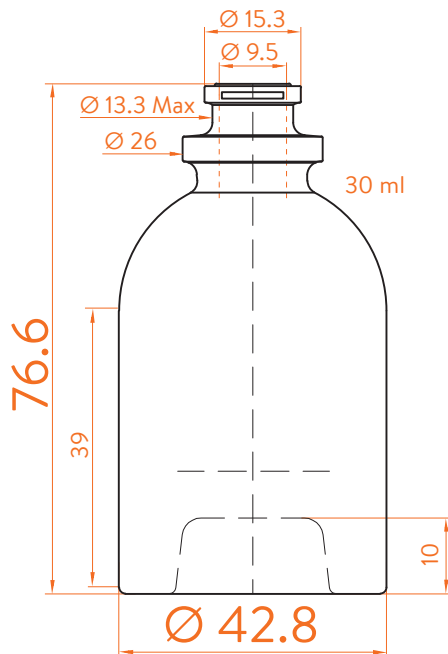

DATOS TÉCNICOS TECHNICAL DATA DONNÉES TECHNIQUES

Peso / Weight / Poids	105 gr
Altura total / Total height / Hauteur totale	76,6 mm
Diámetro del cuerpo / Body diameter / Diamètre du corps	42,8 mm
Ø interno boca / Ø inner mouth / Ø intérieur bouche	9,5 mm
Capacidad a verter / Brimfull / Capacité Ras-Bord	35 ml

30 ml

At first the DA DUOMO range is proposed in 30, 50 and 100 ml.
Following business opportunities, other sizes - from miniature 5 cl to big sizes 300 cl will be added to the range.

The elements detailed in this document are not contractual. They are only indicative.