

DA ATTICO®

estal

www.estal.com
+34 972 821 676



Modelo registrado/
Registered model/
Modèle enregistré

 FEA 15

 EXTRA FLINT

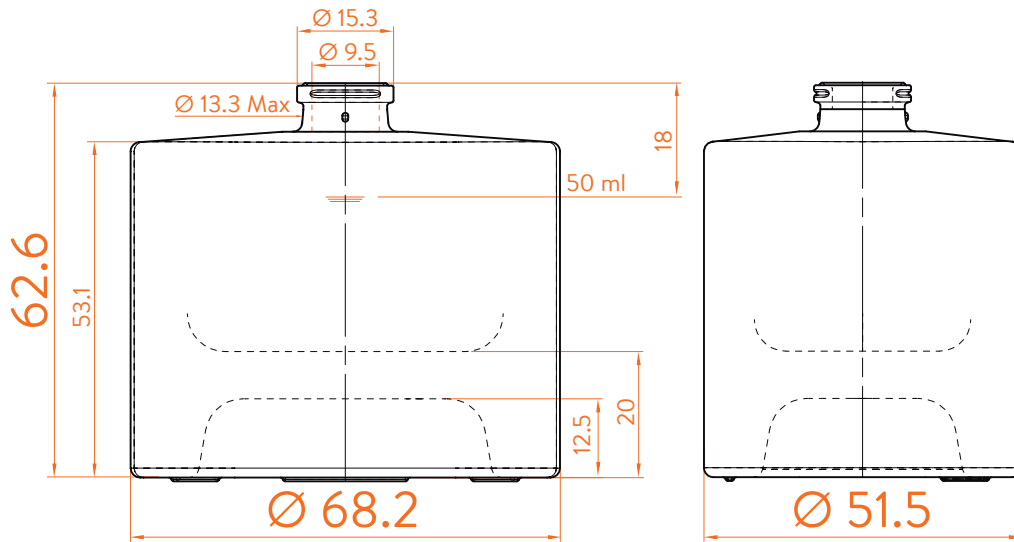

DATOS TÉCNICOS TECHNICAL DATA DONNÉES TECHNIQUES

Peso / Weight / Poids

255 gr

Altura total / Total height / Hauteur totale

62,6 mm

Diámetro del cuerpo / Body diameter / Diamètre du corps

68,2 / 51,5 mm

Ø interno boca / Ø inner mouth / Ø intérieur bouche

9,5 mm

Capacidad a verter / Brimfull / Capacité Ras-Bord

57 ml

50 ml

At first the DA ATTICO range is proposed in 30, 50 and 100 ml.
Following business opportunities, other sizes - from miniature 5 cl to big sizes 300 cl will be added to the range.

The elements detailed in this document are not contractual. They are only indicative.